

TOYOTA RAV 4 ('13-'15)
TOYOTA RAV 4 ('16-)
TOYOTA RAV 4 HYBRID ('16-)

D8.1210 Rev.2 / 2017.10.11

-
- ✦ **Enganche fabricado por URBENI adaptable a la marca del vehículo.**
 - ✦ **Towbar made by URBENI adaptable to the brand of the vehicle.**
 - ✦ **Attelage fabriqué par URBENI adaptable à la marque de ce véhicule.**
 - ✦ **Für dieses Fahrzeug angepasst und hergestellt durch URBENI**
 - ✦ **Dispositivo de traino URBENI adeguato alla marca di questo veicolo.**

URBENI le ofrece una garantía del producto por un periodo de 2 años desde la fecha de entrega. conforme lo dispuesto en la directiva 1999/44/CE y la ley 23/2003, esta garantía está limitada a reemplazar el producto defectuoso y en ningún caso se extenderá a daños o perjuicios consecuenciales.

THE URBENI's products have a warranty period of 2 years after the delivery date, conform to the standard 1999/44/CE, this warranty is limited to the replacement of the defective products, and it will not never cover any derivate damages.

Les produits d'URBENI ont une garantie de 2 ans depuis la date de livraison ce qui est conforme à la Normative Européenne 1999/44CE. Cette garantie inclue de remplacer le produit défectueux, mais en aucun cas les dommages ou préjudices conséquents

URBENI gewährt eine Garantie von einen 2 Jahre in ordnung nach dem Fertigungsnorm. Der Hersteller behält sich das Recht vor die schadhafte Ware zu repaieren oder zu ersetzen und in keinem Fall übernimmt er

Folgekosten für Schäden an Dritten.

Bemerkung: Für einen Mangel am Produkt, der durch den Fahrzeughalter oder eine andere. Person aufgrund unsachgemäßer Benutzung verursacht wurde, übernimmt Urbeni keine Haftung. Alle befestigungsschrauben der KmH nach ca. 1000 Anhänger-Km und bei jeder Fahrzeuginspektion gemäss den angegebenen Anziehdrehmomenten nachziehen

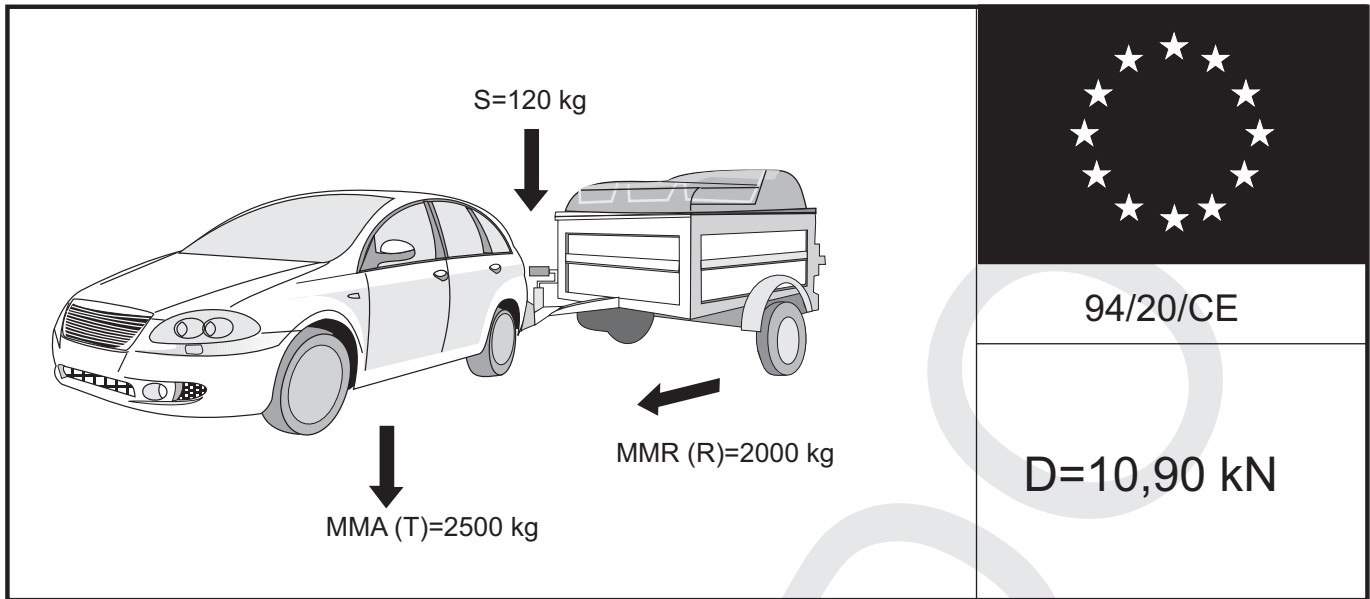

$g = 9,81 \text{ m/sg}^2$

$$D = \frac{T \cdot R}{1000 \cdot (T + R)} \cdot g \quad T = \frac{R \cdot D \cdot 1000}{(g \cdot R) - (1000 \cdot D)} \quad R = \frac{T \cdot D \cdot 1000}{(g \cdot T) - (1000 \cdot D)}$$

kN kg kg

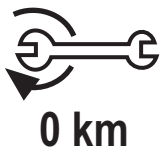

	M8	M10	M12	M14	M16
N · m	23	50	80	135	200

$\varnothing = 50 \text{ mm}$ ✓

$\varnothing < 49 \text{ mm}$ ✗

URBENi

120 kg

S ↓

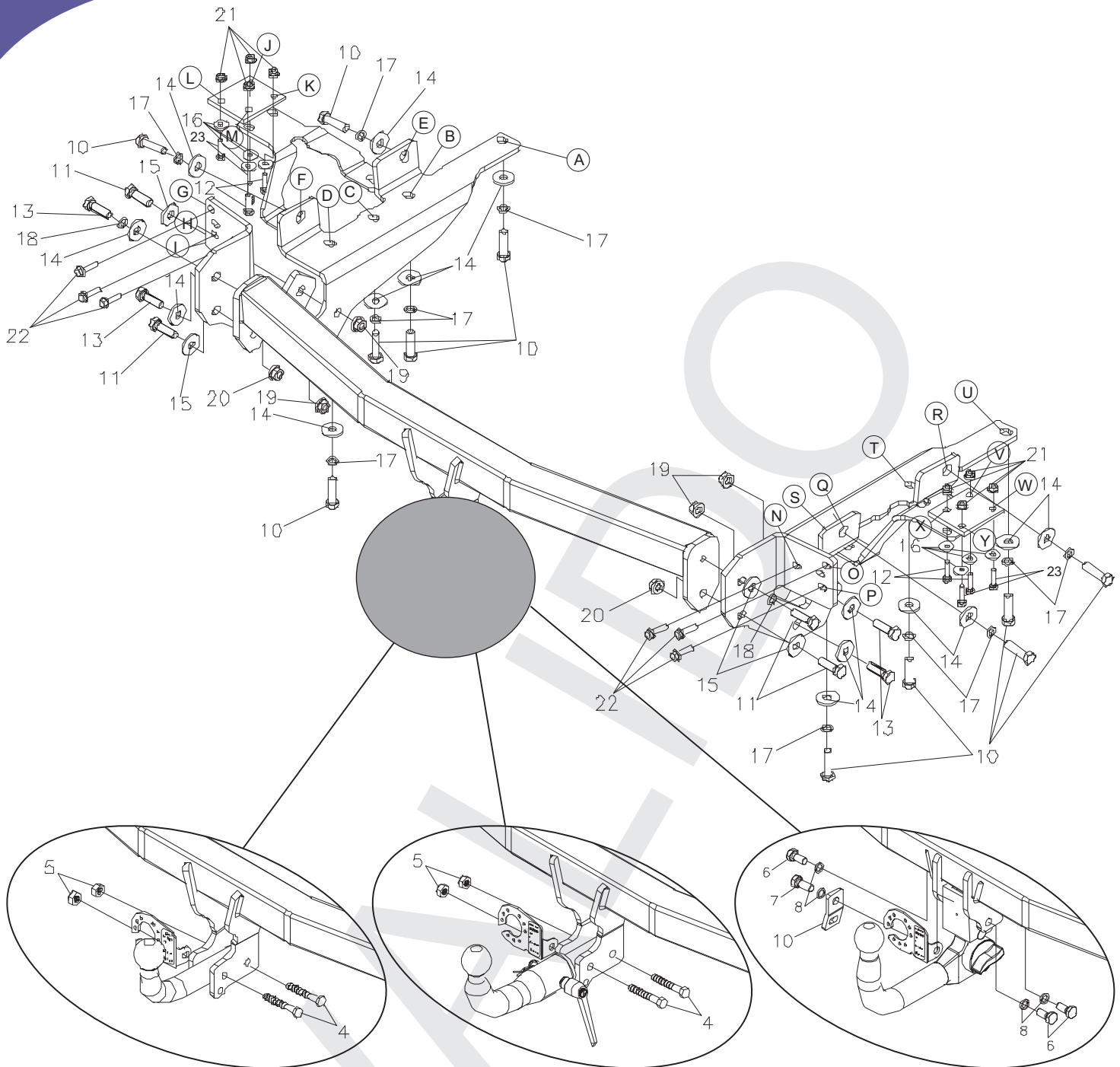

REF: 03865















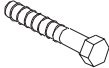

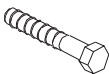
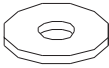
URBENi
 CLASS **A50-X**
 APPROVAL NUMBER
E13 55R-01 3779
 TYPE **T 024**
 D-VALUE
 D **10,90** kN
 MAX.VERT.LOAD.
 S **120** kg
 www.urbeni.com
 MADE IN SPAIN

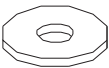

REF: 23865



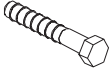

URBENi
 CLASS **A50-X**
 APPROVAL NUMBER
E13 55R-01 3780
 TYPE **T 025 A**
 D-VALUE
 D **10,90** kN
 MAX.VERT.LOAD.
 S **120** kg
 www.urbeni.com
 MADE IN SPAIN

REF: 83865

URBENi
 CLASS **A50-X**
 APPROVAL NUMBER
E13 55R-01 3780
 TYPE **T 025 B**
 D-VALUE
 D **10,90** kN
 MAX.VERT.LOAD.
 S **120** kg
 www.urbeni.com
 MADE IN SPAIN

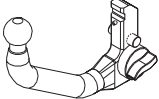
N°		Q	
1		1	
2		1	
3		1	
10		11	M12x1,25x40 DIN 931
11		4	M14x40 DIN 933
12		4	M8x30 DIN 933
13		4	M12x40 DIN 933
14		15	M12 DIN 9021
15		4	M14 DIN 9021
16		8	M8 DIN 9021
17		11	M12 DIN 7980
18		2	M14 DIN 7980
19		4	M12 DIN 6923
20		2	M14 DIN 6923
21		8	M8 DIN 6923
22		6	
23		4	M8x20 DIN 933

			
4		2	M12x80 DIN 931
5		2	M12 DIN 985

			
6		3	M12x25 DIN 933
7		4	M12 DIN 985
8		1	M12x30 DIN933

INVALID

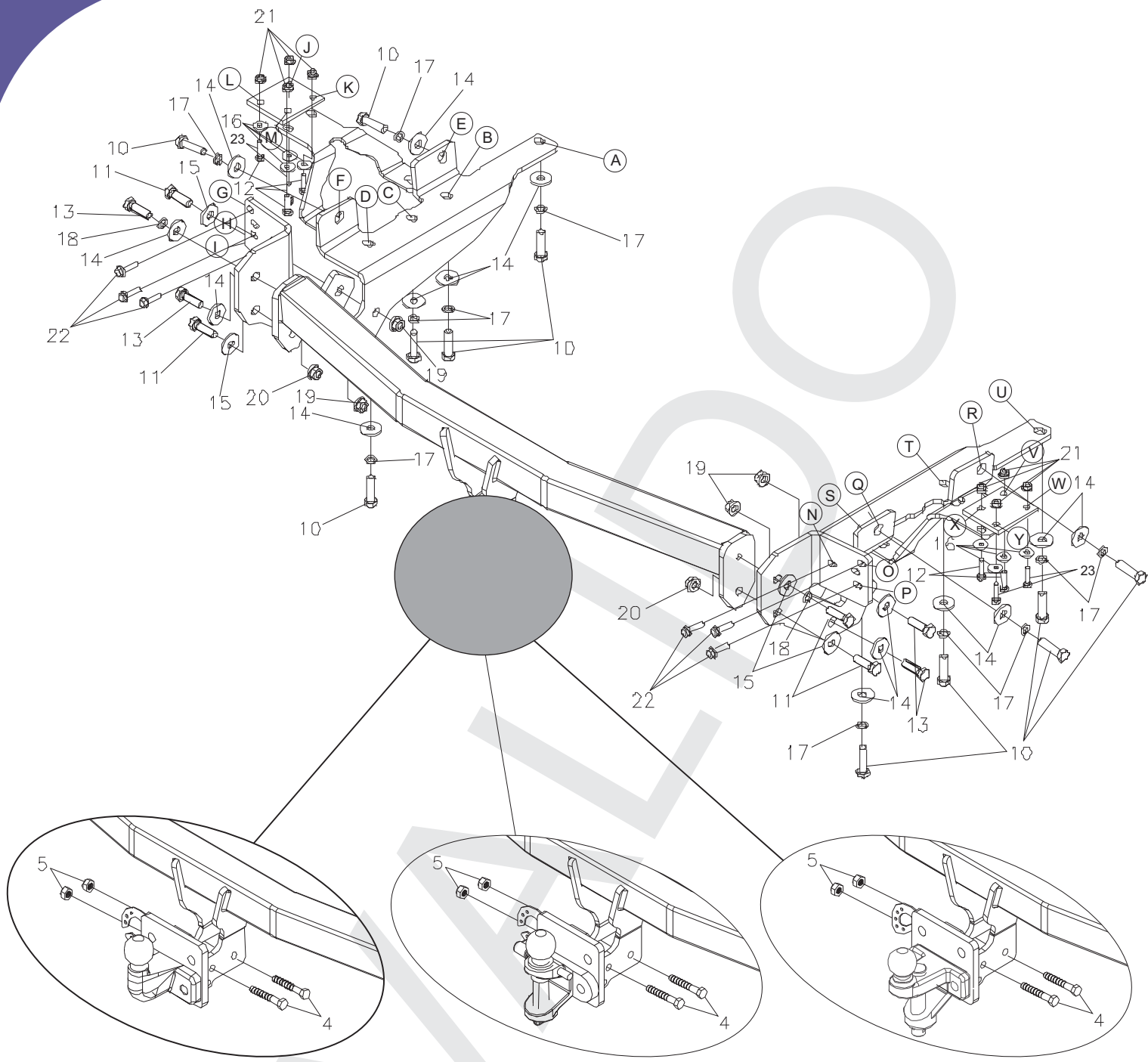

REF: 03866

URBENi

CLASS **A50-X**

APPROVAL NUMBER
E13 55R-01 3781

TYPE **T 026**

D-VALUE
 D **10,90** kN

MAX.VERT.LOAD.
 S **120** kg

www.urbeni.com
 MADE IN SPAIN

REF: 13866

URBENi

CLASS **A50-X**

APPROVAL NUMBER
E13 55R-01 3781

TYPE **T 026**

D-VALUE
 D **10,90** kN

MAX.VERT.LOAD.
 S **120** kg

www.urbeni.com
 MADE IN SPAIN

REF: 1338065

URBENi

CLASS **F**















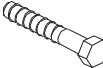

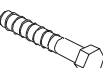

APPROVAL NUMBER
E13 55R-01 3782





TYPE **T 027**

D-VALUE
 D **10,90** kN

MAX.VERT.LOAD.
 S **120** kg

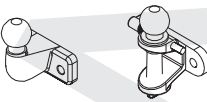
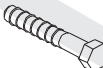
www.urbeni.com
 MADE IN SPAIN

N°		Q	
1		1	
2		1	
3		1	
10		11	M12x1,25x40 DIN 931
11		4	M14x40 DIN 933
12		4	M8x30 DIN 933
13		4	M12x40 DIN 933
14		15	M12 DIN 9021
15		4	M14 DIN 9021
16		8	M8 DIN 9021
17		11	M12 DIN 7980
18		2	M14 DIN 7980
19		4	M12 DIN 6923
20		2	M14 DIN 6923
21		8	M8 DIN 6923
22		6	
23		4	M8x20 DIN 933

			
4		2	M12x80 DIN 931
5		2	M12 DIN 985
6		2	M16x50 DIN 931
7		2	M16 DIN 985

1

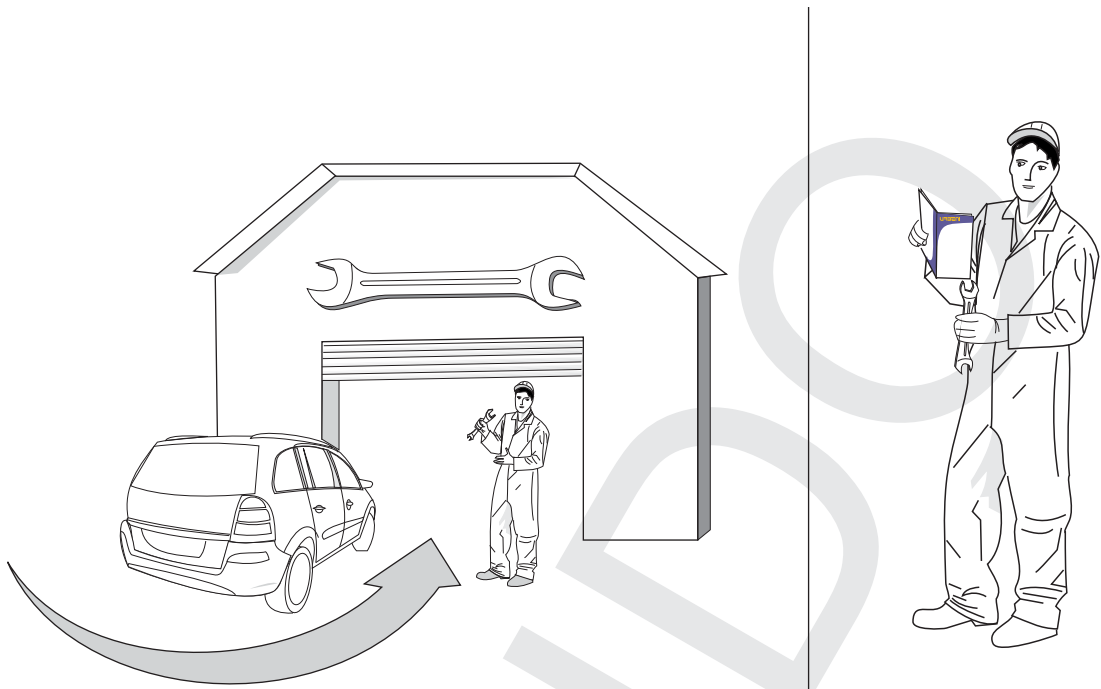

2

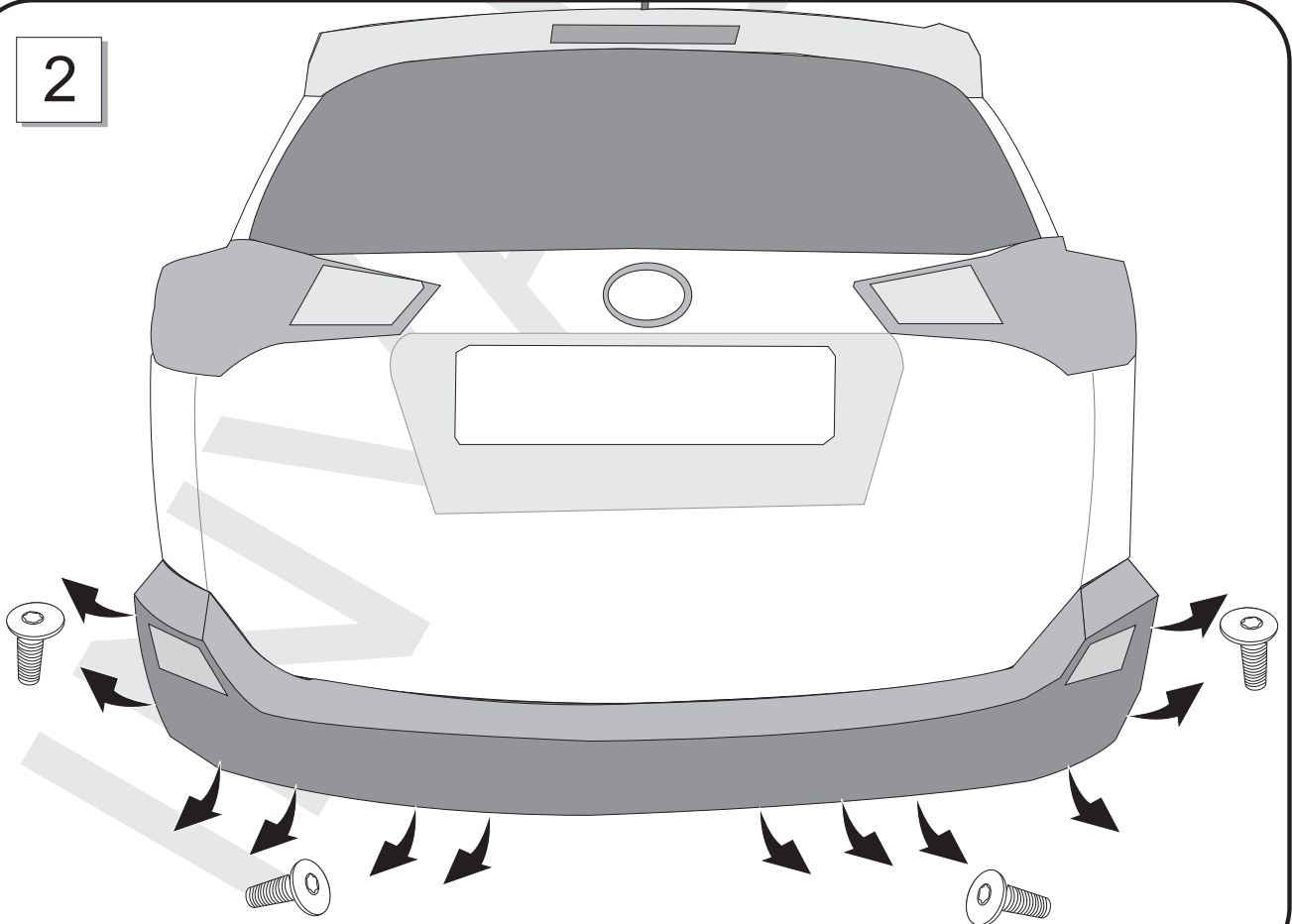

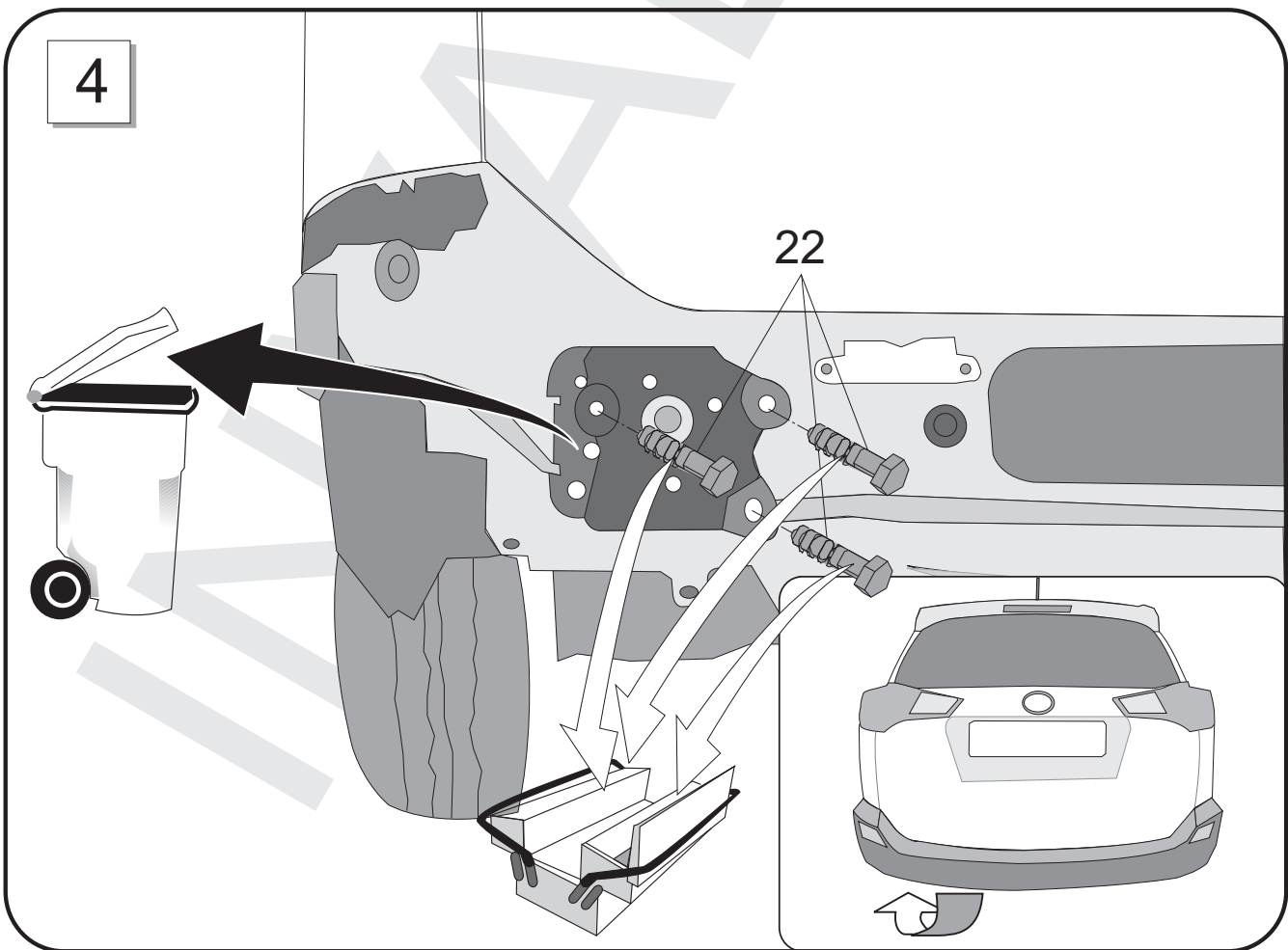
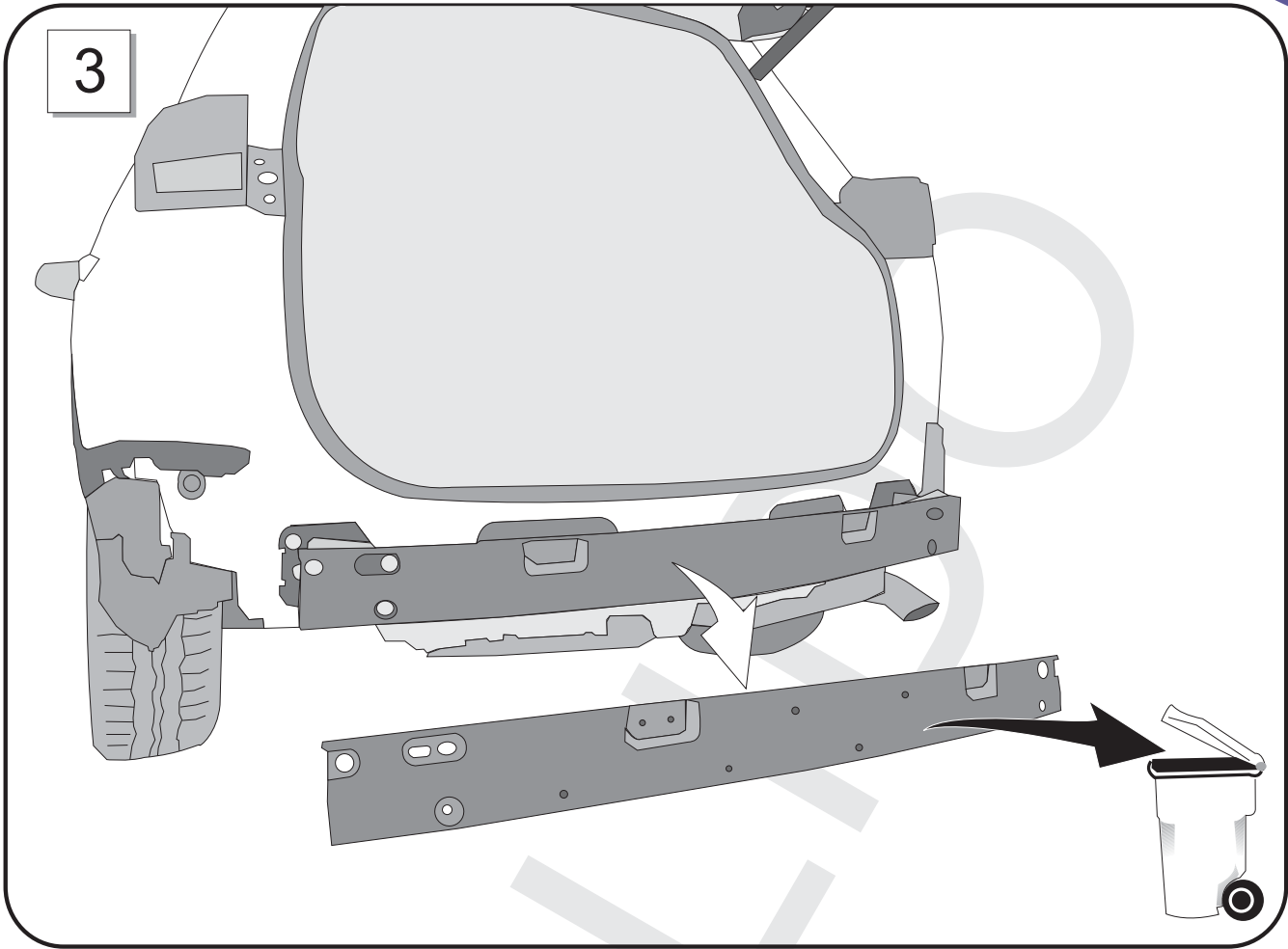

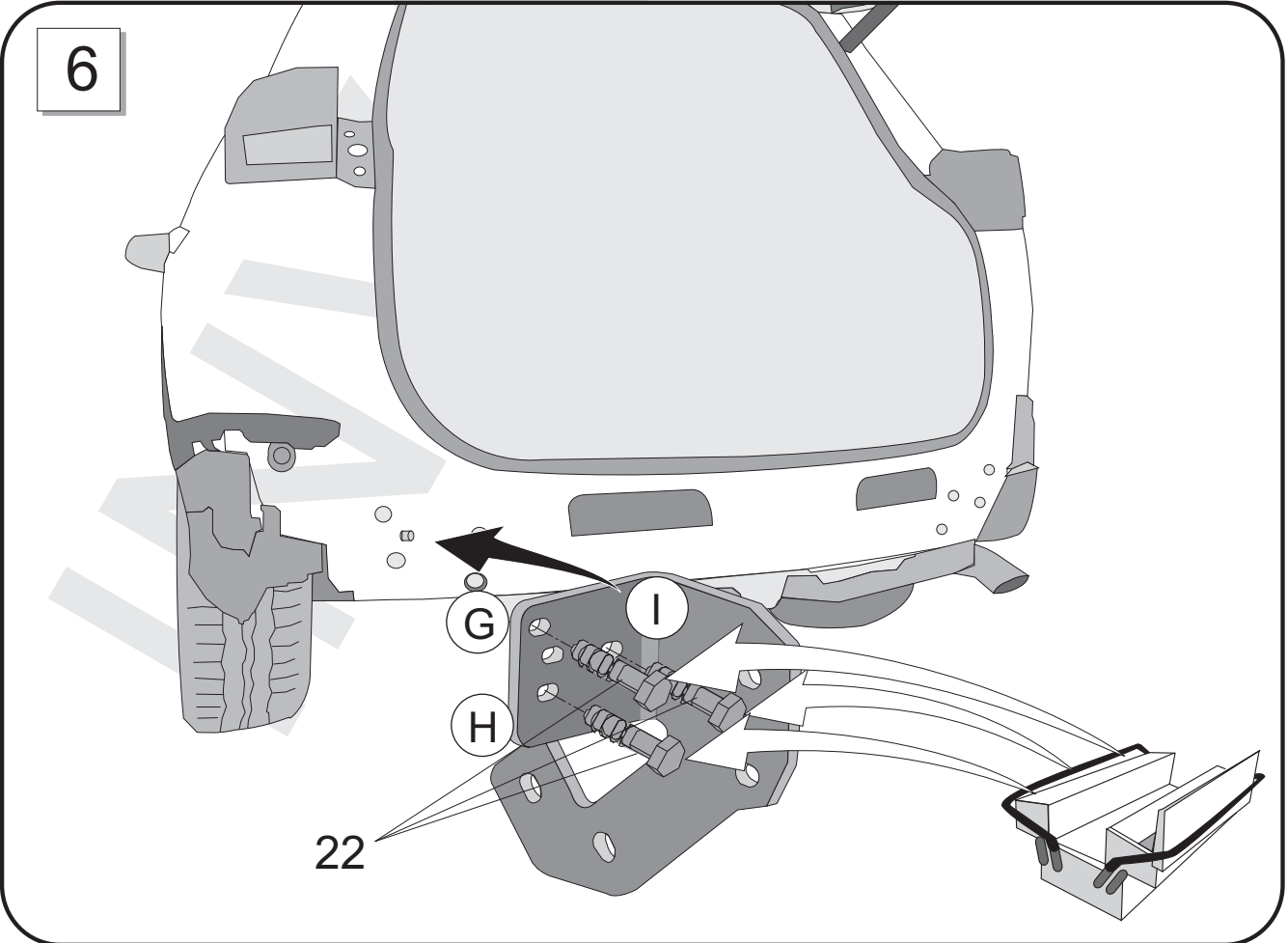
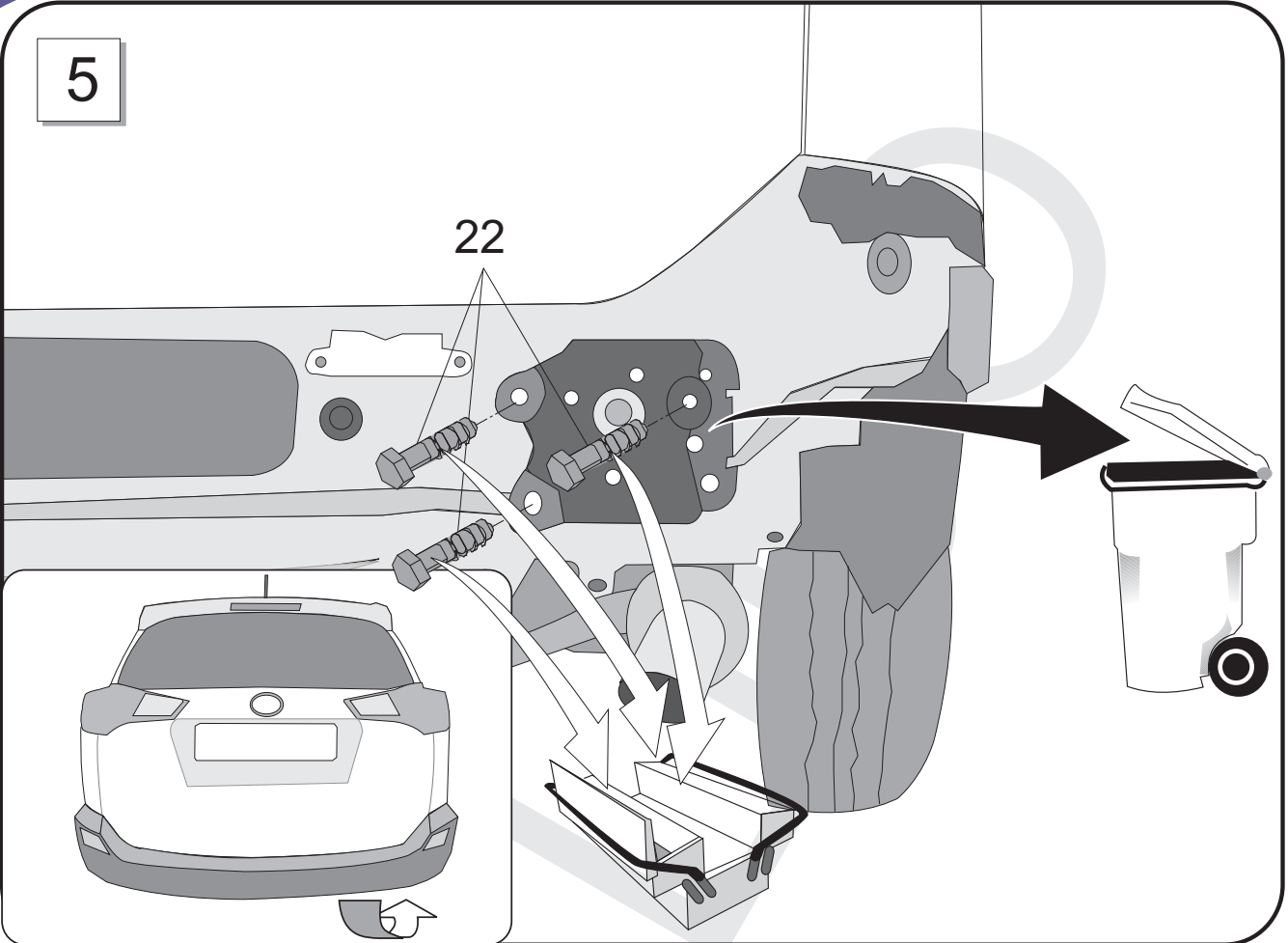

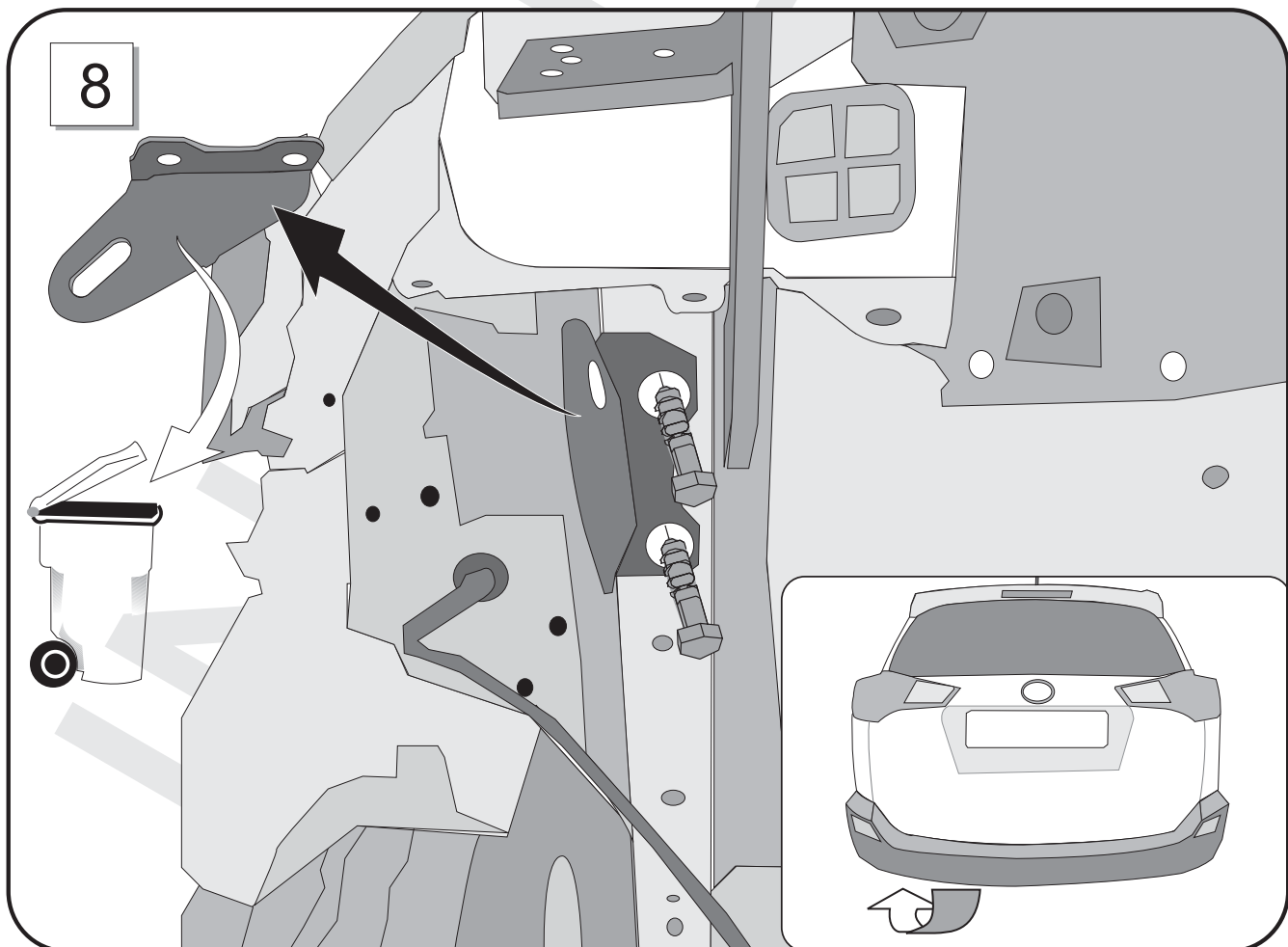
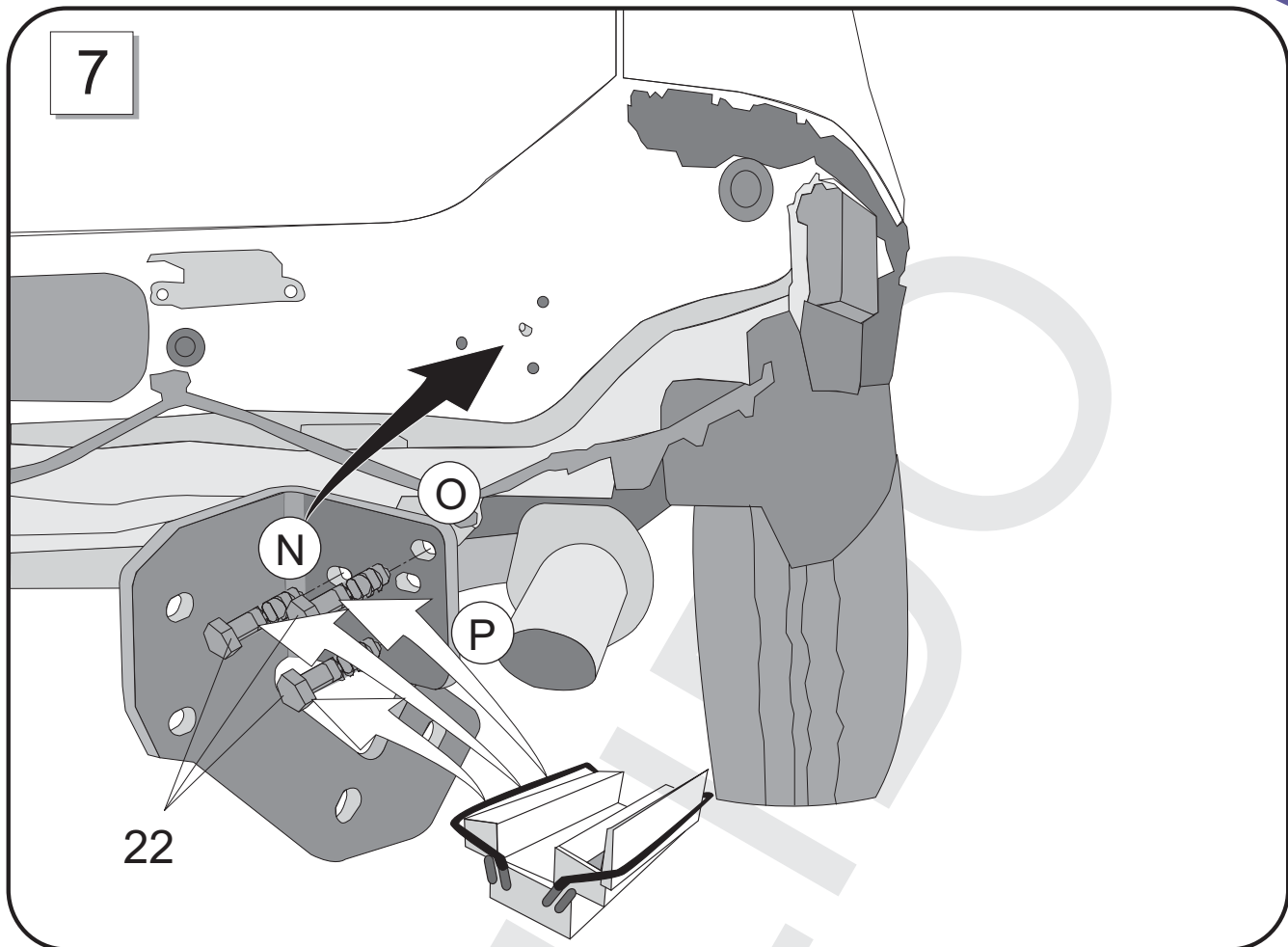

9

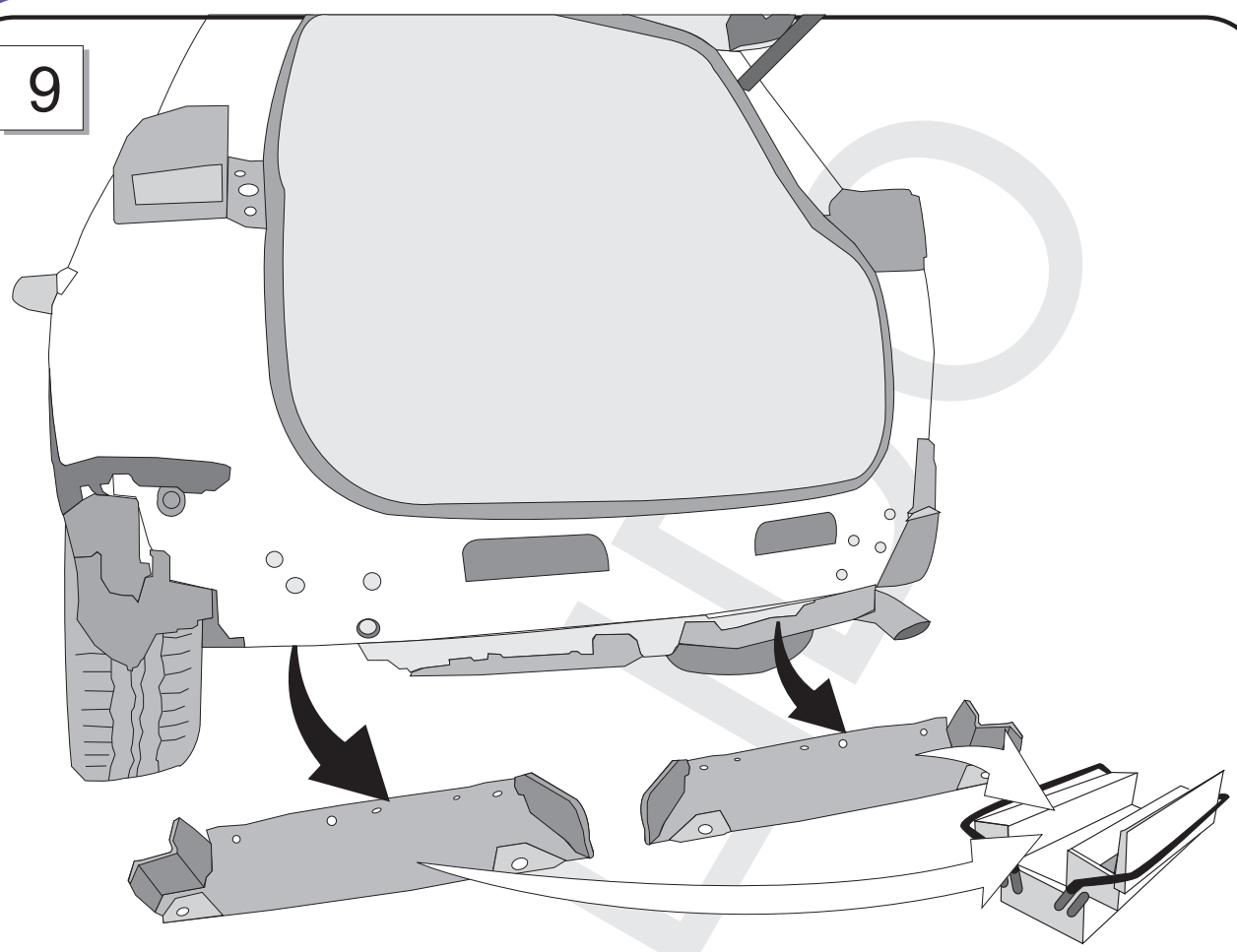

10

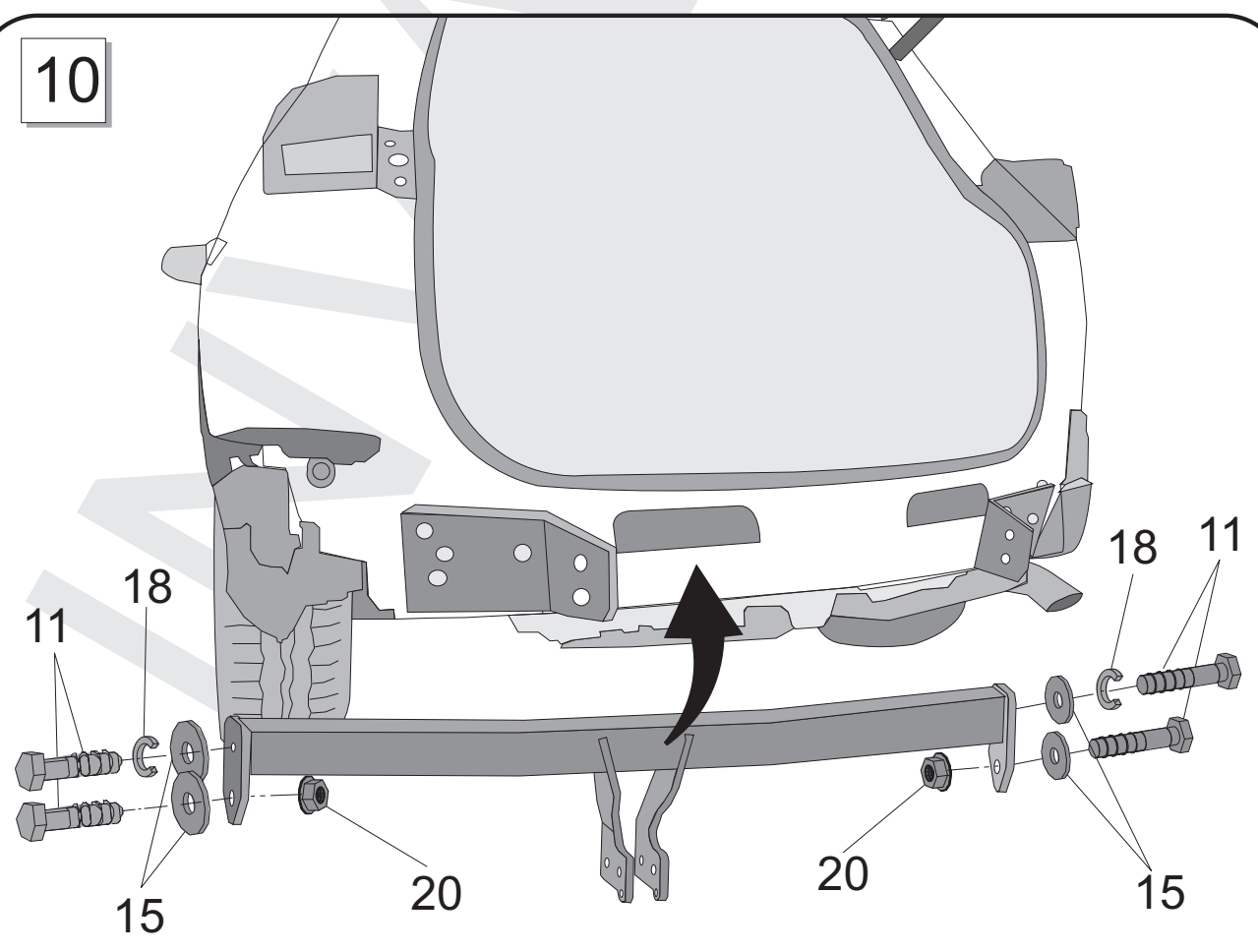

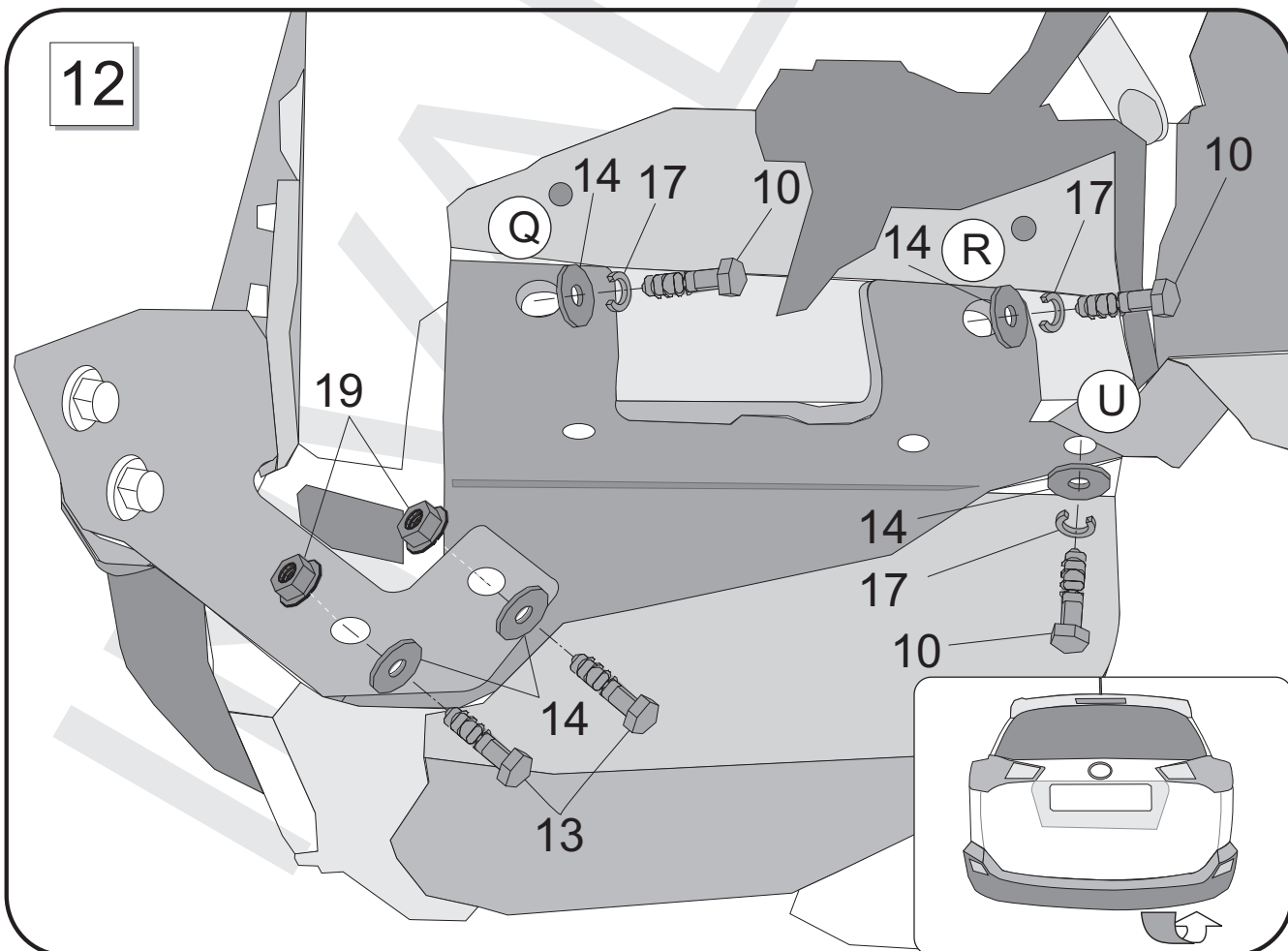
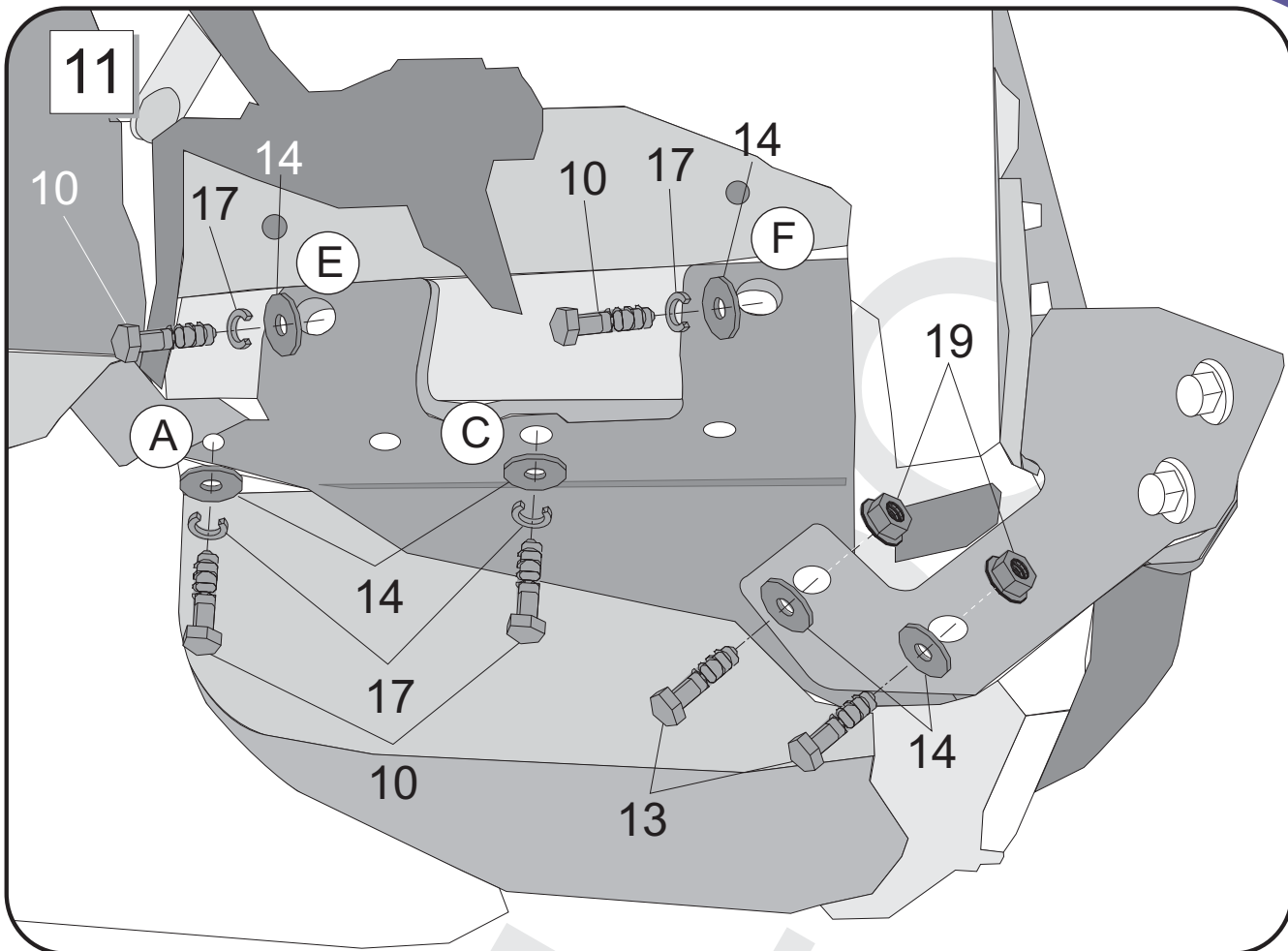

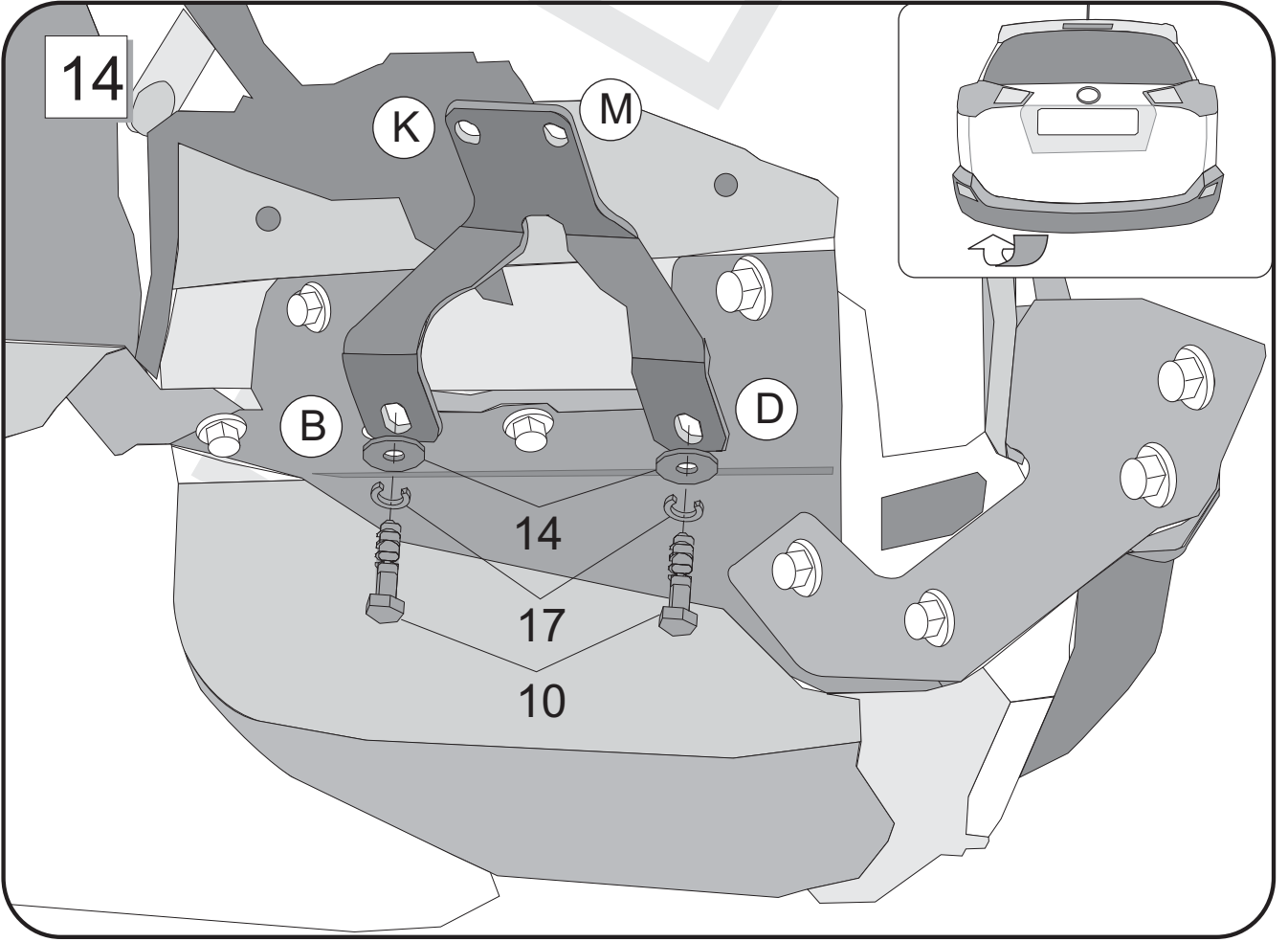
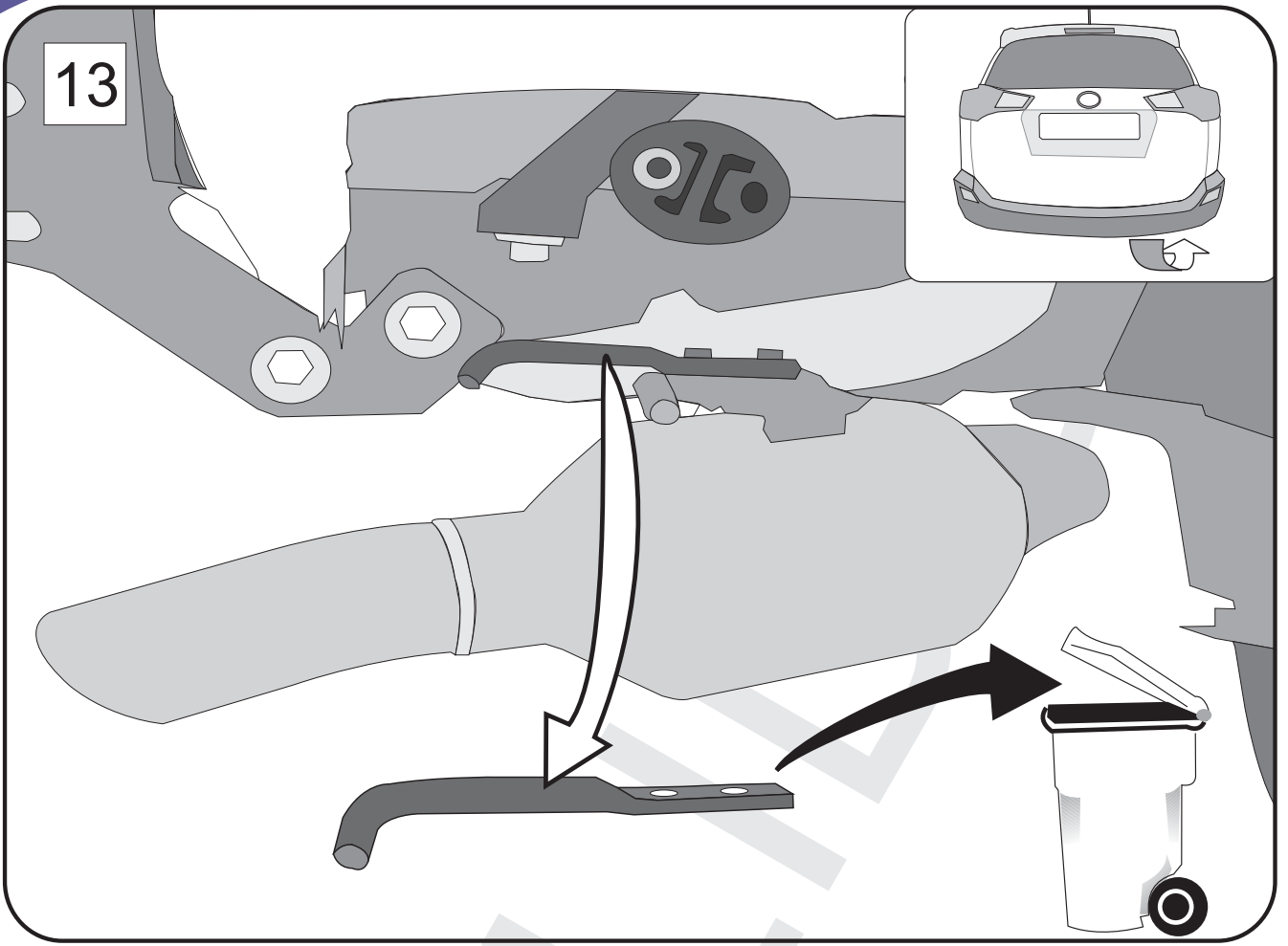

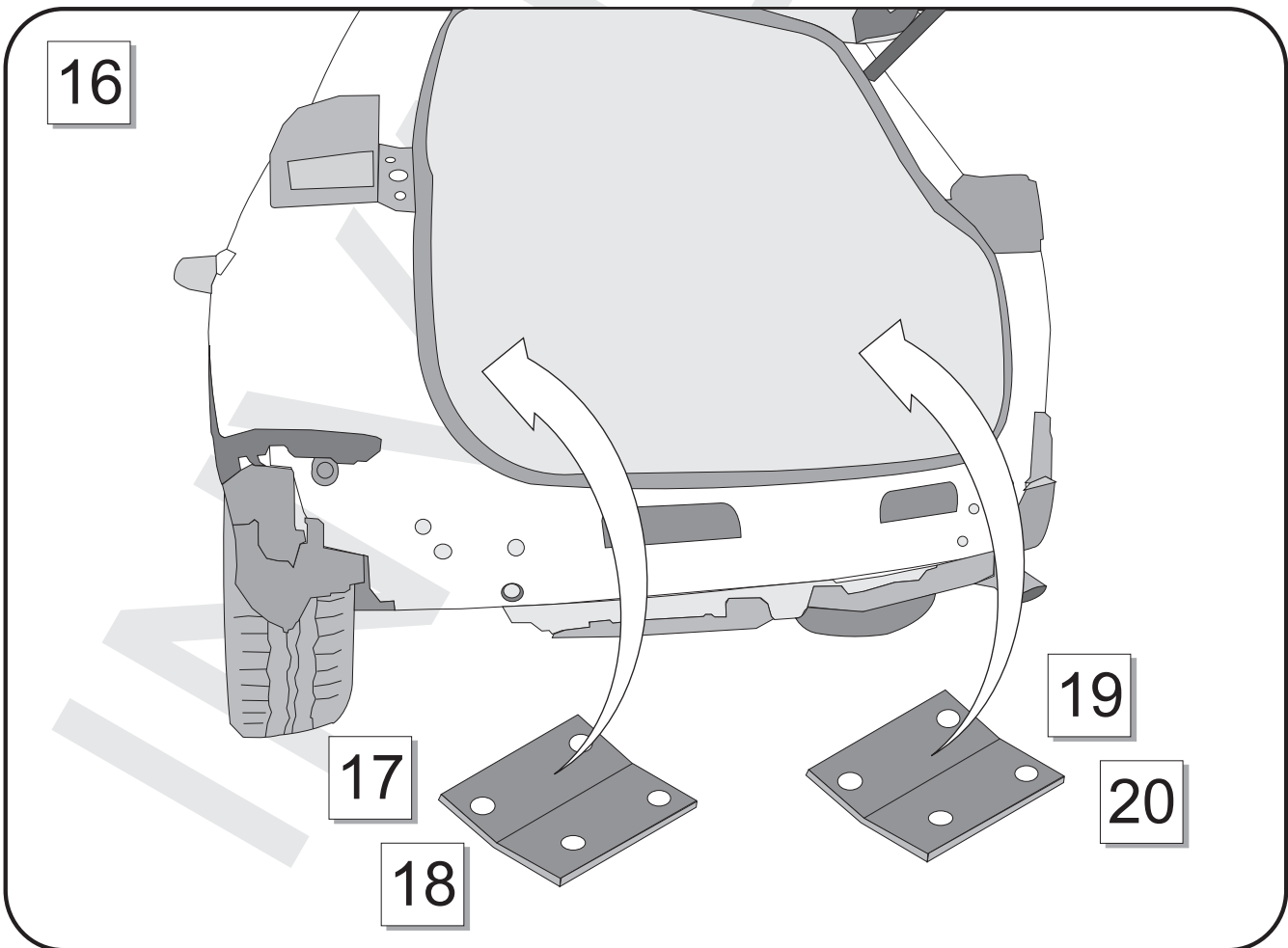
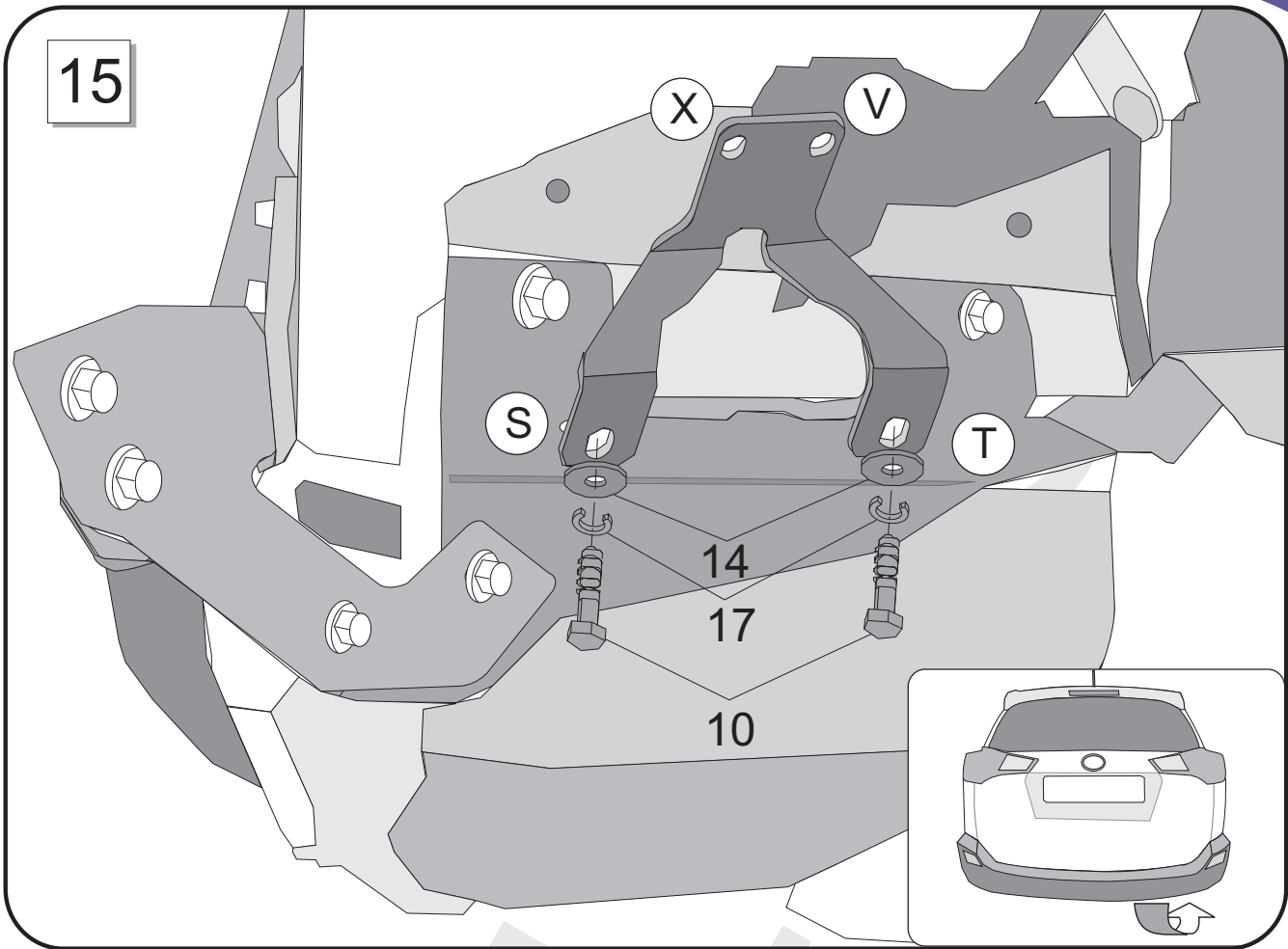

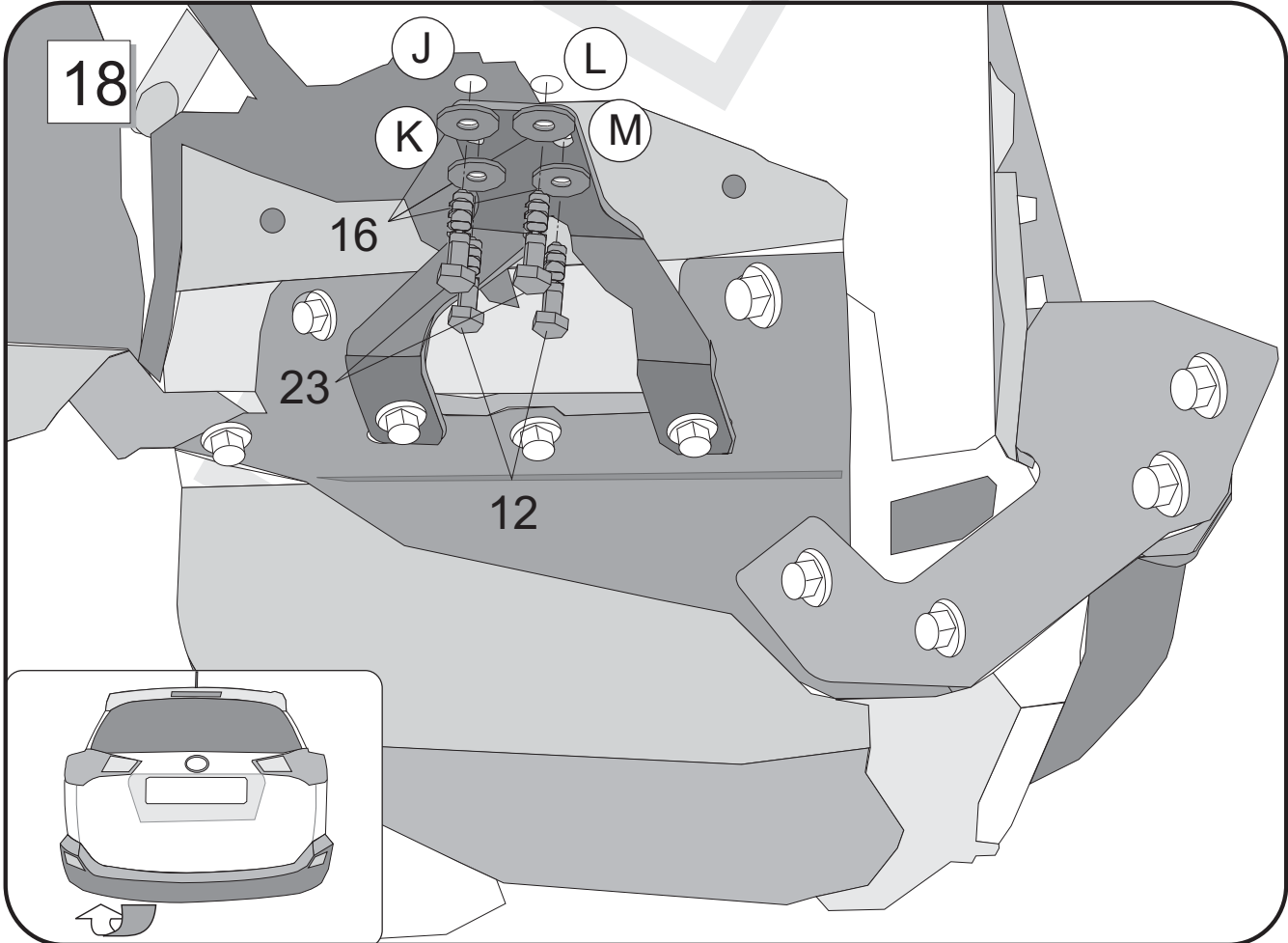
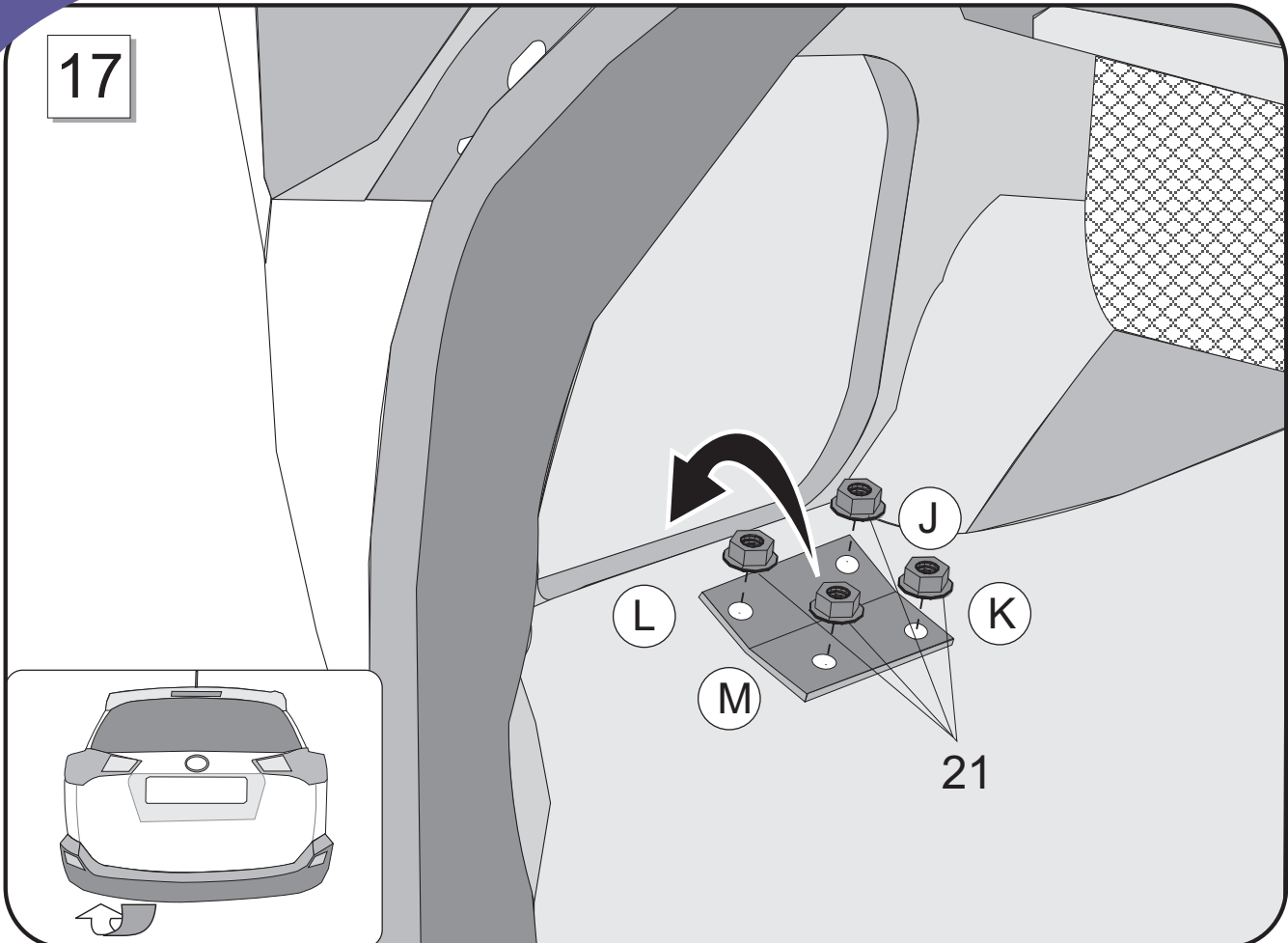

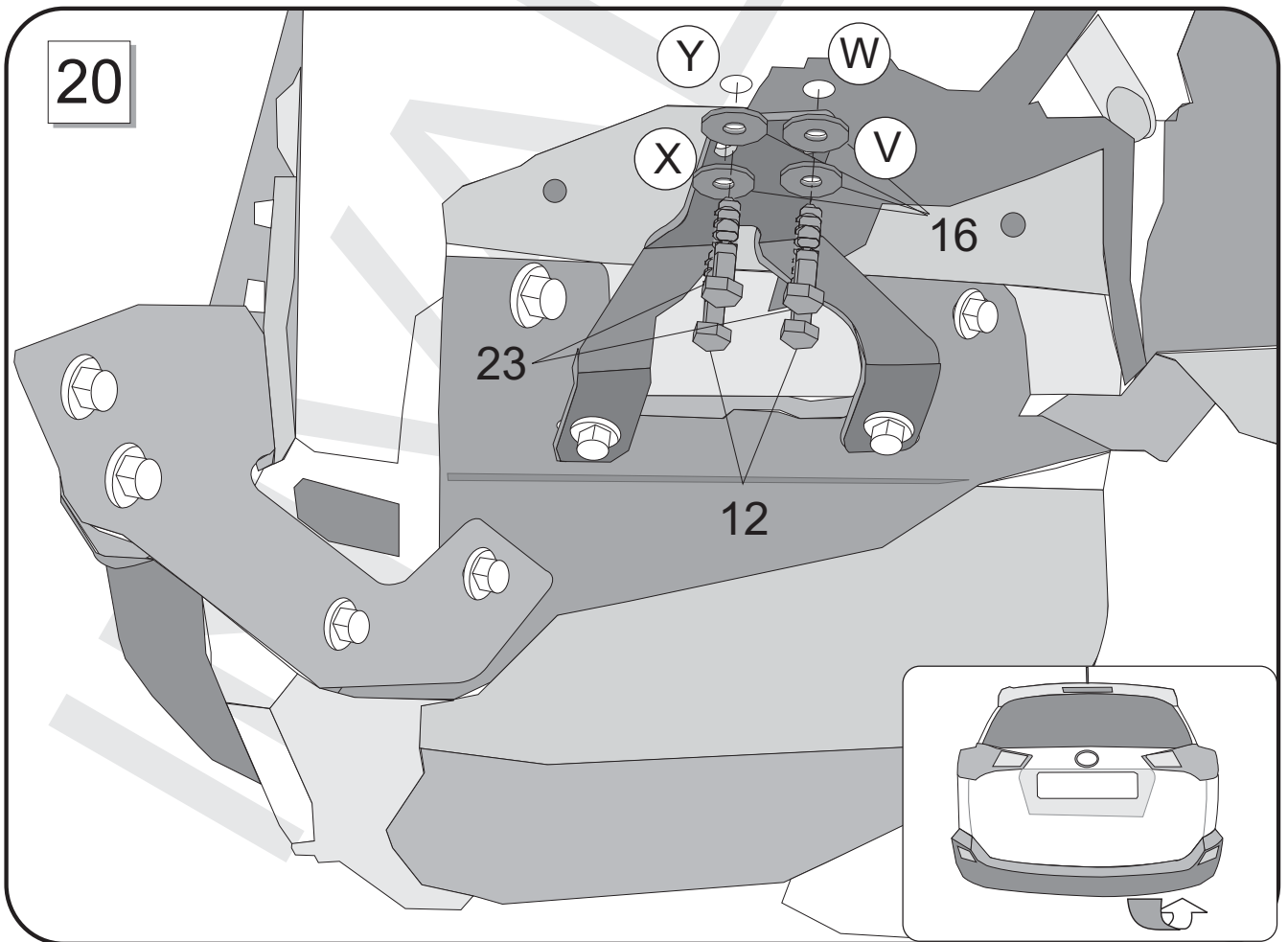
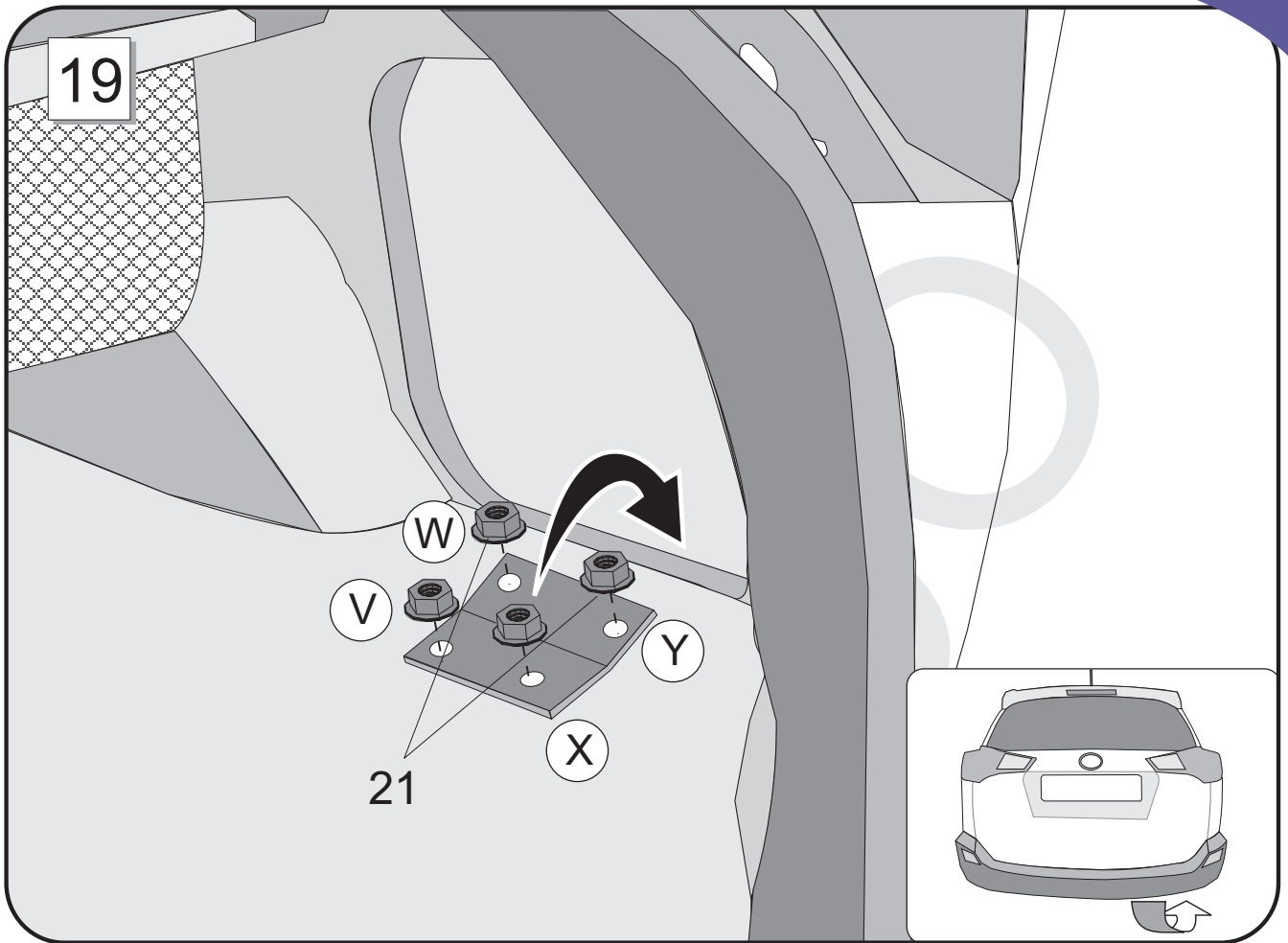

21

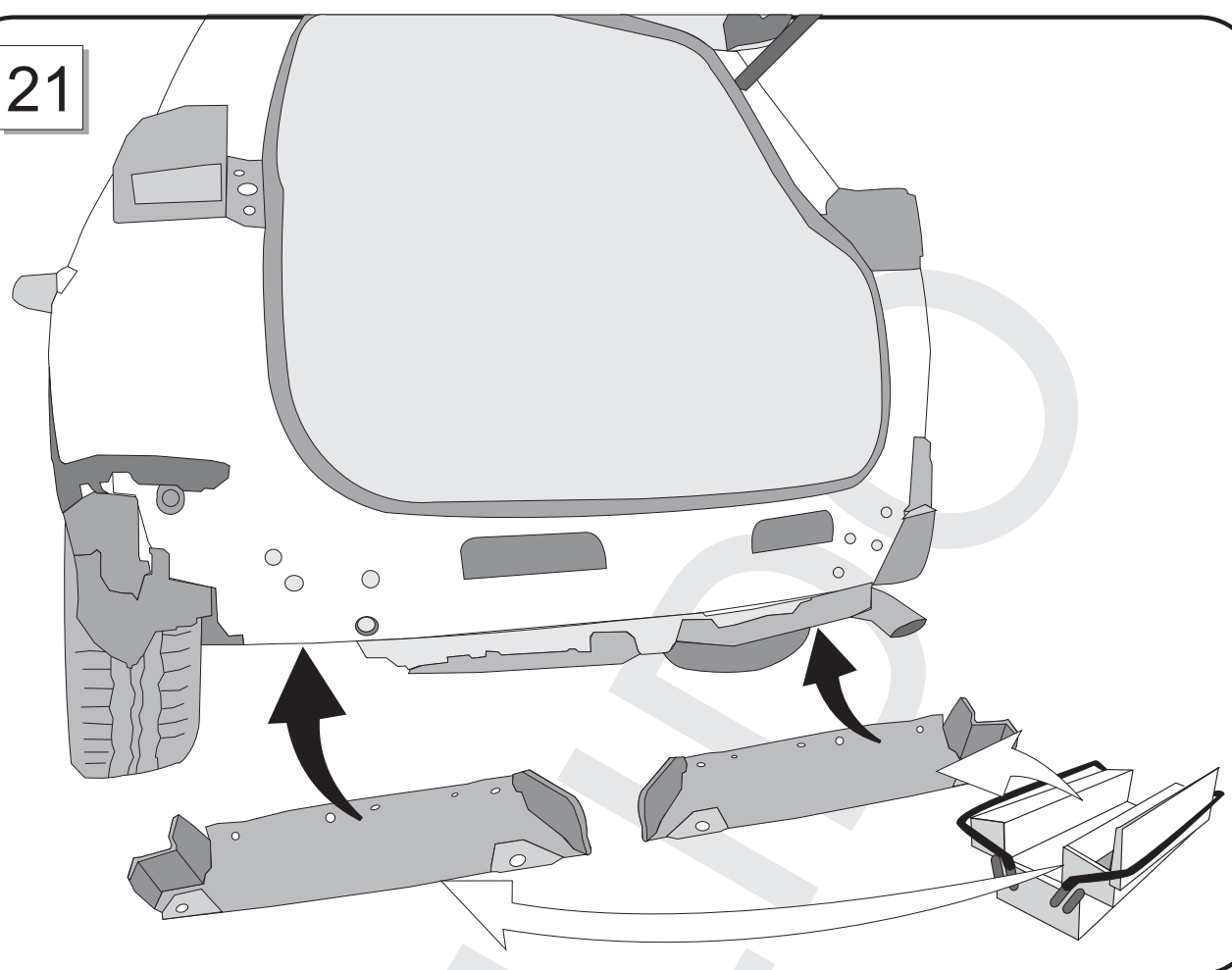

22

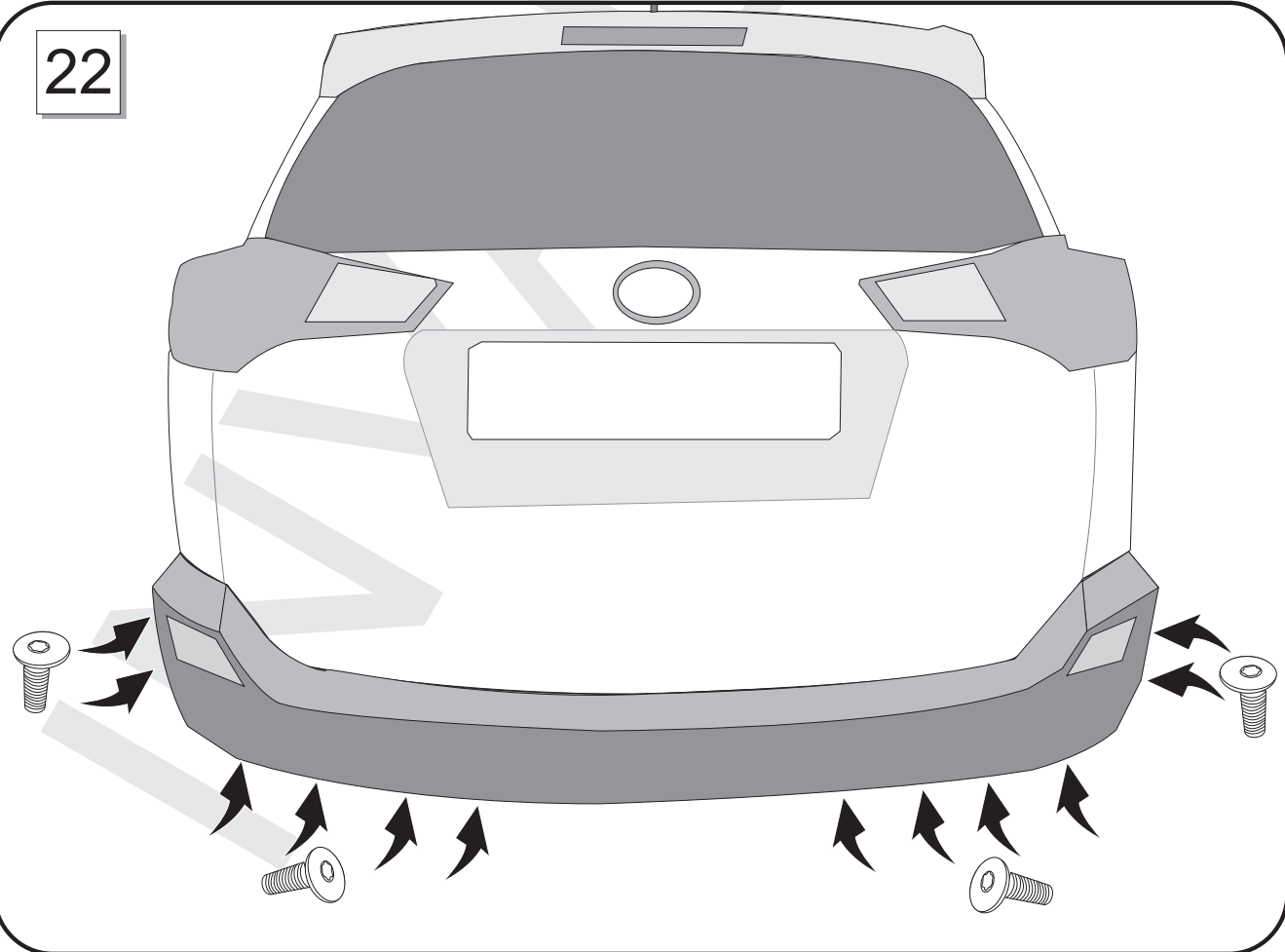

23

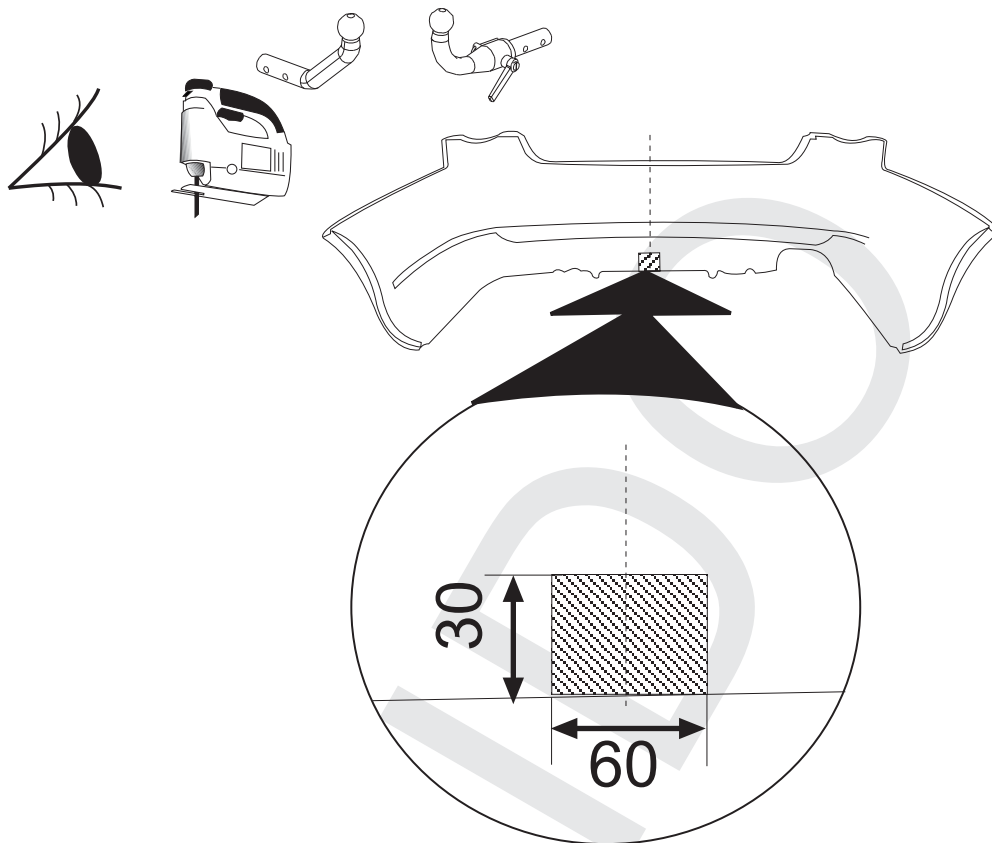

24

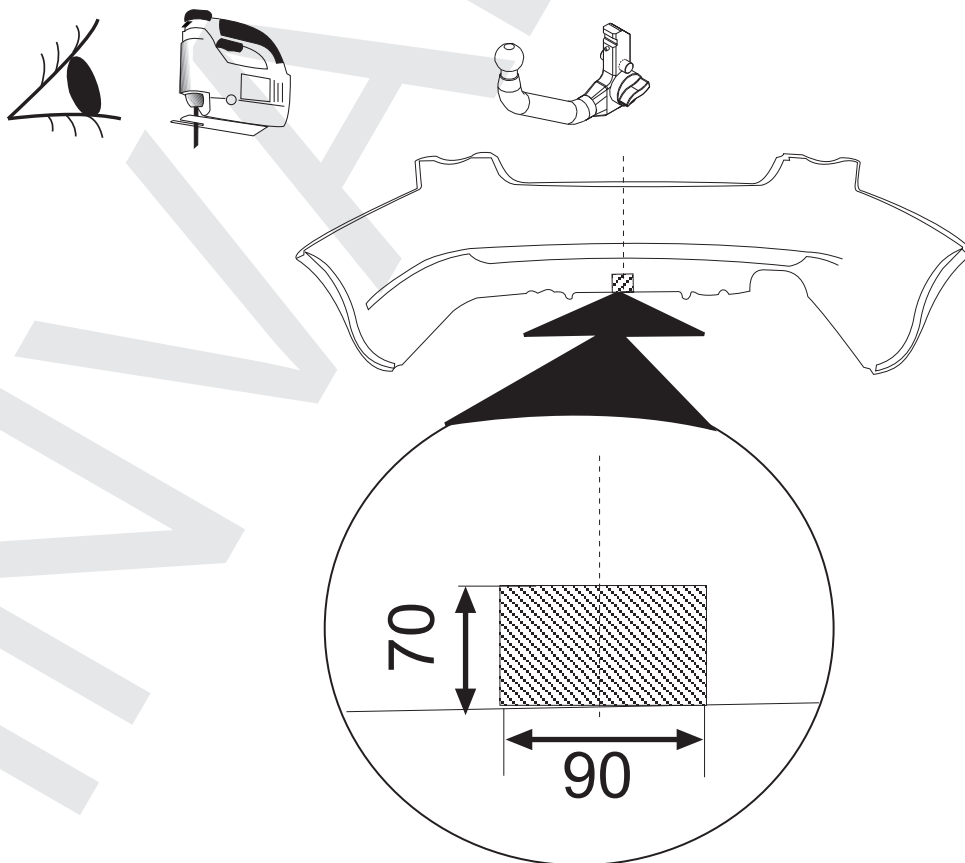

25

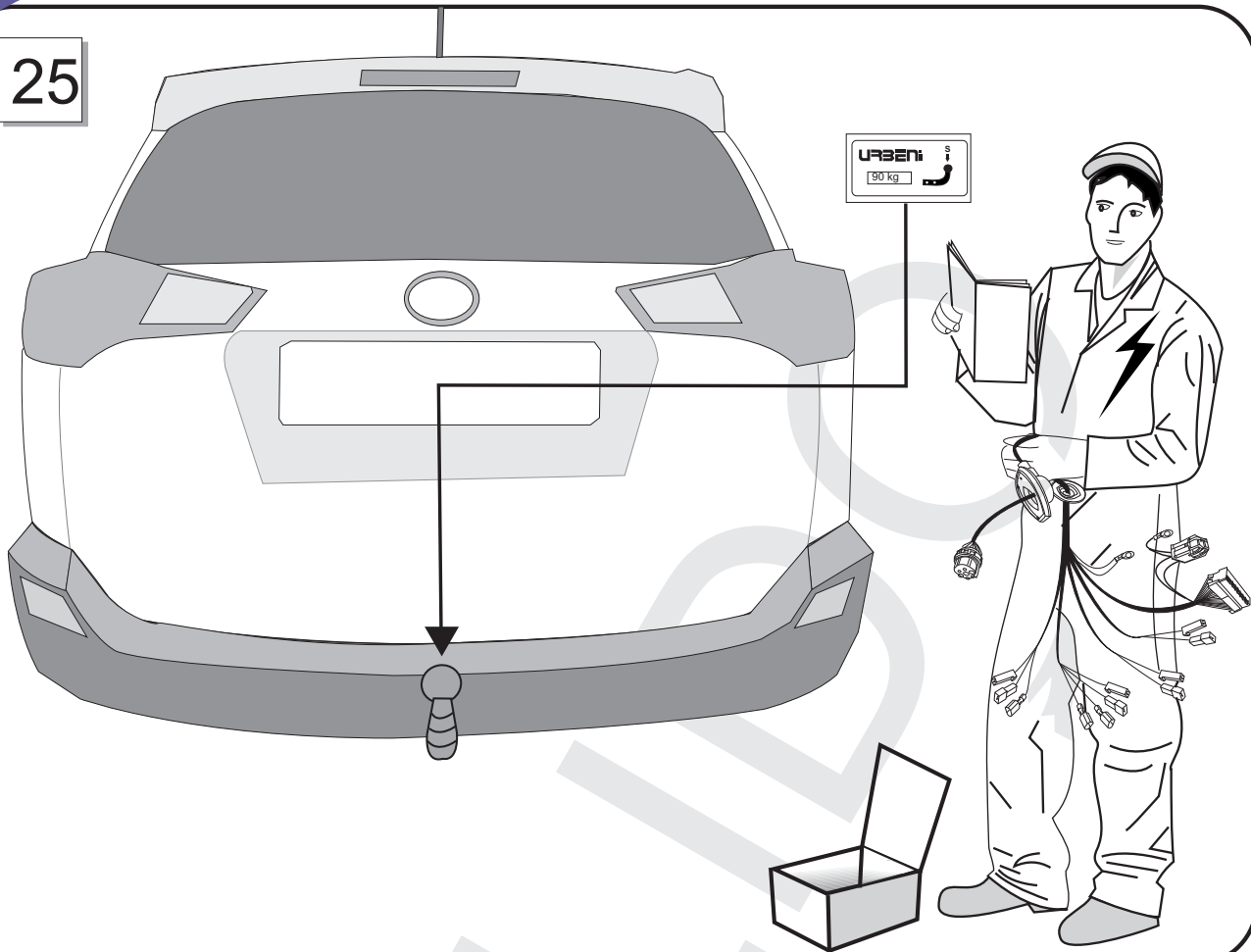

26

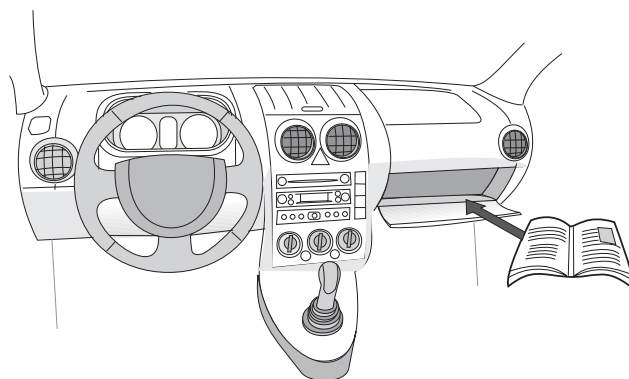
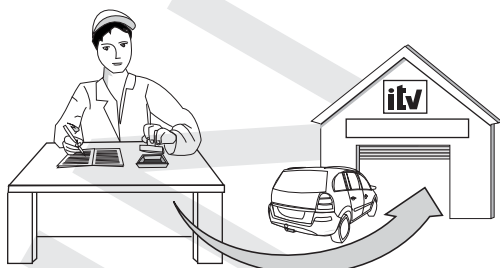

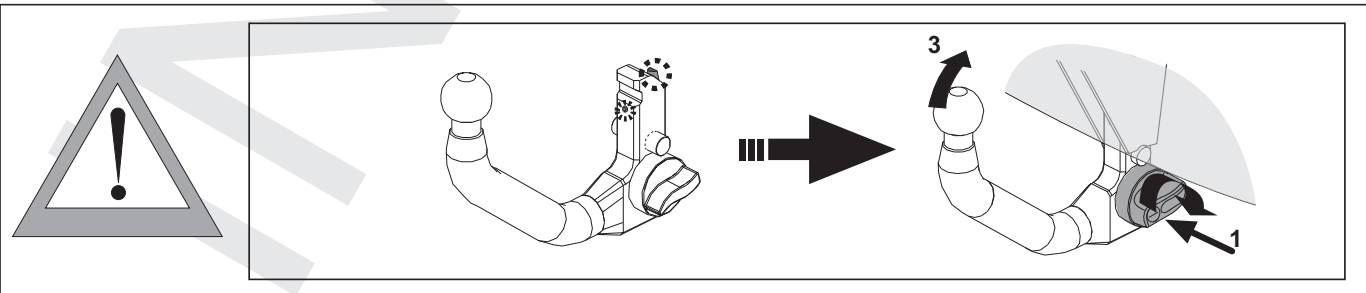
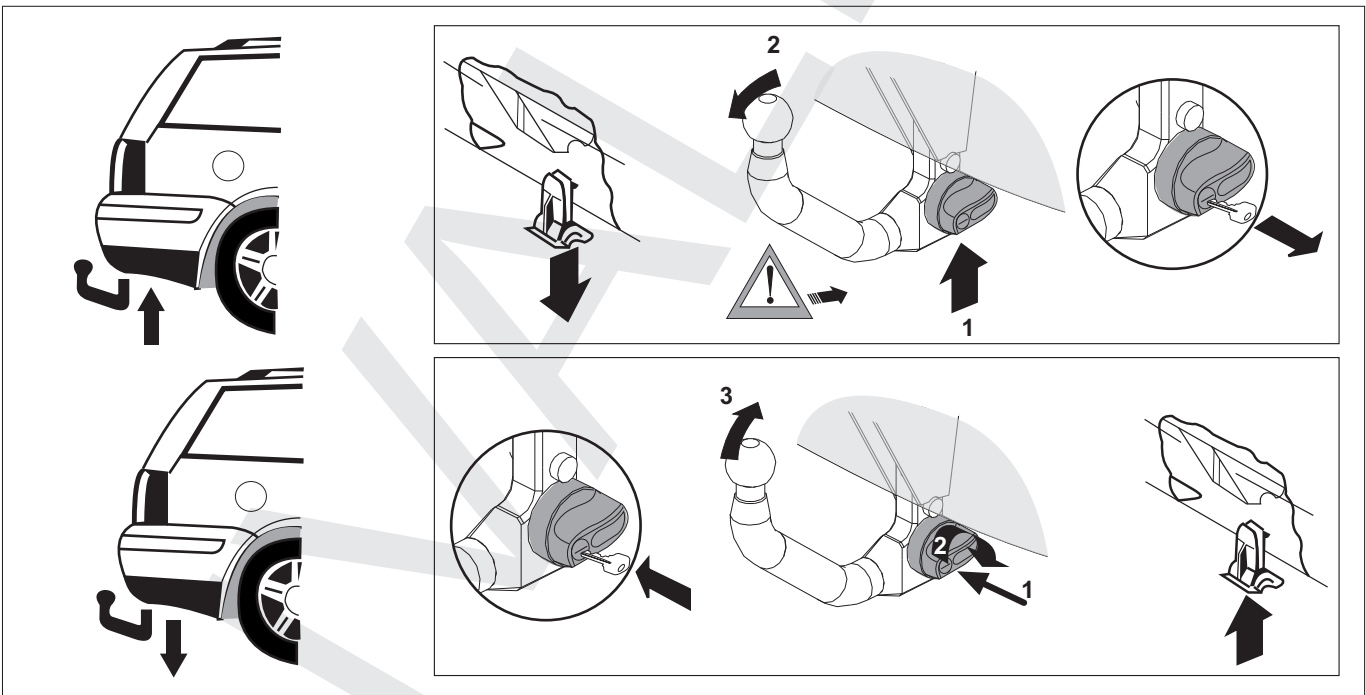
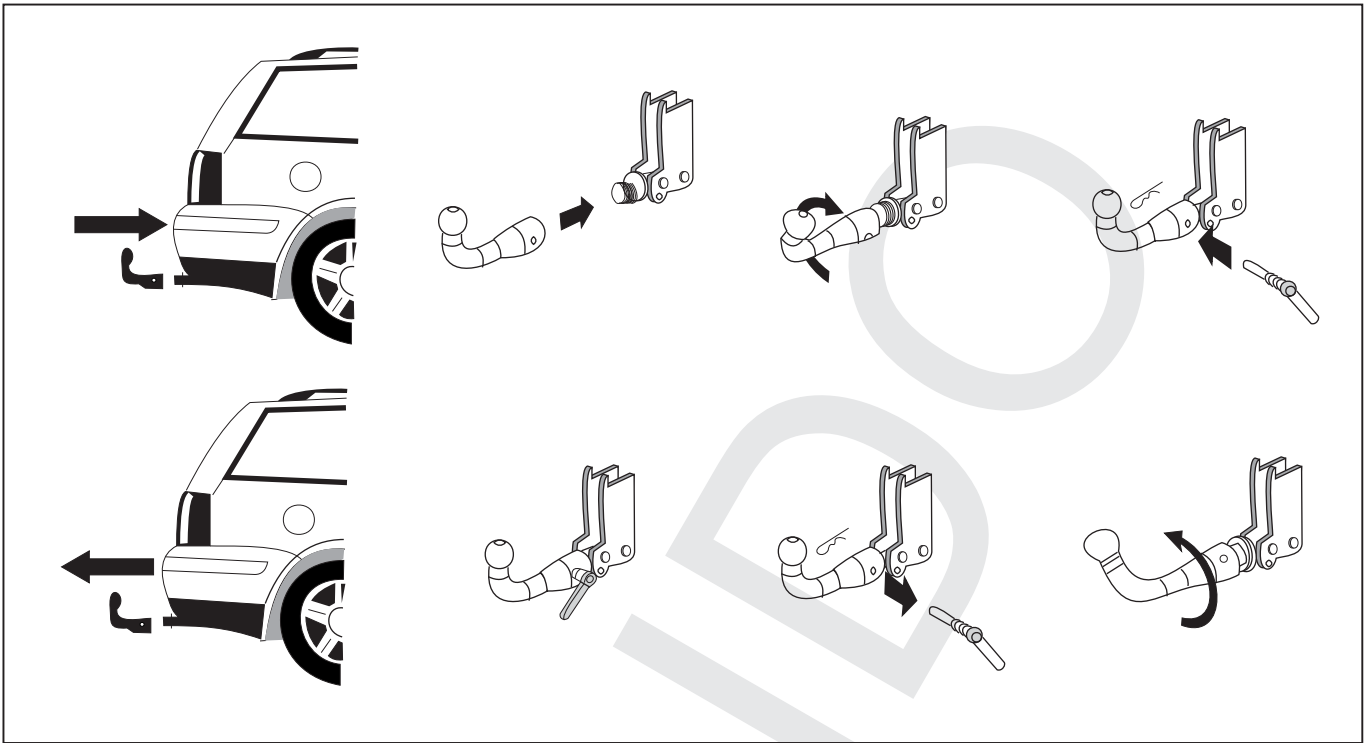



GRAND-DUCHE DE LUXEMBOURG
Ministère du Développement durable
et des Infrastructures
Département des Transports

L-2938 Luxembourg

SOCIÉTÉ NATIONALE DE
CERTIFICATION ET D'HOMOLOGATION

Registre de Commerce: B 27180

L-5201 Sandweiler



REFERENCE : E13*55R00*55R01*3779*00

ANNEXES : -Rapport Technique
-Fiche de Renseignements du constructeur

Sandweiler, le 15 Janvier 2014

Communication concernant²
Communication concerning²



- la délivrance d'une homologation
approval granted
- l'extension d'homologation
approval extended
- le refus d'homologation
approval refused
- le retrait d'homologation
approval withdraw
- l'arrêt définitif de la production
production definitively discontinued

d'un type de dispositif ou de pièces mécaniques d'attelage en vertu du Règlement N°55
of a type of mechanical coupling device or component pursuant to Regulation N°55

Numéro d'homologation : E13*55R00*55R01*3779*00
Approval number :

Marque d'homologation :  55R-01 3779
Approval mark :

- | | | |
|----|---|--|
| 1. | Marque de fabrique ou de commerce du dispositif ou des pièces:
Trade name or mark of the device or component : | URBENI |
| 2. | Nom du fabricant du type du dispositif ou des pièces :
Manufacture's name for the type of device or component : | T 024 |
| 3. | Nom et adresse du fabricant :
Manufacture's name and address : | URBENI, S.L.
Ctra.Nacional II, Km 303, Pol.Ind.centrovia,
C/Buenos Aires nº10
E-50198 LA MUELA (Zaragoza) |
| 4. | Le cas échéant, nom et adresse du représentant du constructeur :
If applicable, name and address of manufacturer's representative : | None |
| 5. | Noms et marques de fabrique d'autres fournisseurs figurant sur le dispositif ou les pièces :
Alternative supplier's names or trade marks applied to the device or component : | MORENO REMONDO or MVG |



GRAND-DUCHE DE LUXEMBOURG
 Ministère du D-eveloppement durable
 et des Infrastructures
 Departement des Transports
 L-2938 Luxembourg

SOCIETE NATIONALE DE
 CERTIFICATION ET D'HOMOLOGATION

Registre de Commerce: B 27180
 L-5201 Sandweiler



REFERENCE : E13*55R00*55R01*3780*00

ANNEXES : -Rapport Technique
 -Fiche de Renseignements du constructeur

Sandweiler, le 15 Janvier 2014

Communication concernant²
 Communication concerning²



- la délivrance d'une homologation
approval granted
- l'extension d'homologation
approval extended
- le refus d'homologation
approval refused
- le retrait d'homologation
approval withdraw
- l'arrêt définitif de la production
production definitel y discontinued

d'un type de dispositif ou de pièces mécaniques d'attelage en vertu du Règlement N°55
of a type of mechanical couling device or componet pursuant to Regulation N°55

Numéro d'homologation : E13*55R00*55R01*3780*00
 Approval number :

Marque d'homologation :  55R-01 3780
 Approval mark :

- | | | |
|----|--|--|
| 1. | Marque de fabrique ou de commerce du dispositif ou des pièces:
Trade name or mark of the device or component : | URBENI |
| 2. | Nom du fabricant du type du dispositif ou des pièces :
Manufacture's name for the type of device or component : | T 025 |
| 3. | Nom et adresse du fabricant :
Manufacture's name and address : | URBENI, S.L.
Ctra.Nacional II, Km 303, Pol.Ind.centrovía,
C/Buenos Aires nº10
E-50198 LA MUELA (Zaragoza) |
| 4. | Le cas échéant, nom et adresse du représentant du constructeur :
<i>If applicable, name and address of manufacturer's representative :</i> | None |
| 5. | Noms et marques de fabrique d'autres fournisseurs figurant sur le dispositif ou les pièces :
<i>Alternative supllier's names or trade marks applied to the device or component :</i> | MORENO REMONDO or MVG |

DA COMPILARE PER IL COLLAUDO

DICHIARAZIONE DI CORETTO MONTAGGIO

La sottoscritta Ditta dichiara di aver montato in maniera corretta ed in conformità alle prescrizioni sia del costruttore del veicolo che del costruttore del dispositivo stesso il seguente dispositivo di attacco meccanico:

Tipo:

Il dispositivo di attacco meccanico sopra descritto è stato installato su autoveicolo tipo:

.....

targa:

.....

Si dichiara inoltre di aver informato l'utente del veicolo sull'USO e MANUTENZIONE del dispositivo stesso.

.....

TIMBRO E FIRMA

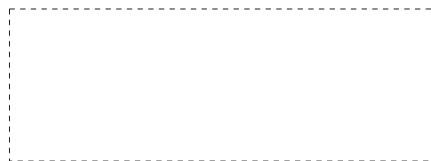

Dispositivo di traino

codice:

Per autoveicoli:

Tipo:

Clase e tipo di attacco:

Omologazione:

Valor D:

Massa Massima

Rimorchiabile:

Carico Verticale Massimo:

Larghezza max.

Rimorquiabile

per Caravan e T.A.T.S.: Vedere CARTA di
CIRCOLAZIONE VEICOLO

(motrice) + 70 cm =
arrotondare ai 5 cm superiore

(vedi D.M. 28/05/85)



CERTIFICADO DE MONTAJE

D., expresamente autorizado por la empresa....., domiciliada en provincia de, calle nº teléfono, dedicada a la actividad, con nº de Registro Industrialy nº de registro especial (1).....

CERTIFICA

Que la mencionada empresa ha realizado la/s reforma/s, y asume la responsabilidad de la ejecución, sobre el vehículo marca tipo variante denominación comercial matrícula y nº de bastidor de acuerdo con:

La normativa vigente en materia de reformas de vehículos.
Las normas del fabricante del vehículo aplicables a la/s reforma/s llevadas a cabo en dicho vehículo.
El proyecto técnico de la/s reforma/s, adjunto al expediente.

OBSERVACIONES:

INSTALACIÓN DE DISPOSITIVO PARA REMOLCAR,

MARCA:

Nº HOMOLOGACIÓN: e..... *55R00*55R01*.....

VALOR D:kN

VALOR S:Kg

M.M.R.:Kg

Se garantiza que los equipos o sistemas modificados cumplen lo previsto en el artículo 6 del Reglamento General de vehículos y, en su caso, en el artículo 5 del Real Decreto 147/1986, de 10 de enero, por el que se regula la actividad industrial en talleres de vehículos automóviles, de equipos y sus componentes, modificados por 455/2010, de 16 de abril, por el que se modifica el Real Decreto 1457/1986, de 10 de enero, por el que se regulan la actividad industrial y la prestación de servicios en los talleres de reparación de vehículos automóviles, de sus equipos y componentes.

..... a de de 20.....

Firma y Sello

Fdo.:

(1) En el caso de que la reforma sea efectuada por un fabricante se indicará N/A





URBENI, S.L.

Pol. Centrovía Ctra. N-II km 303
LA MUELA (ZARAGOZA)
P.P.

